

Preisliste Büromöbel Bralco Reception

Stand Mai 2009

e@sy- working

Italienische Büromöbel

Uwe Heckmann

Bentheimer Strasse 4

D-48527 Nordhorn

Telefon: 05921-179 10 72

Fax: 01805 - 006534 2613

www.easyworking.org

info@easyworking.org

Alle Preise zzgl. MWST. sowie ggfl. Fracht und Montage siehe unsere AGBs

Finiture e colori
Finishing and colors
Finitions et couleurs
Oberfläche und Farbpalette
Afwerking en kleur
Acabados y colores

	CL	PT	RS	L	AM	AC	RN	WE	GP	CT	HN	HB
<p>Verniciato epox alluminio - Aluminium epoxy painted Peint epoxy aluminium - Pulverbeschichtung Aluminium Epox-gevend aluminium - Pintado epoxiáico aluminio</p> <p>Legno mogano tinto palissandro - Palisander stained mahogany wood Acajou teinté palissandre - Matagonholz, Palisander Nachbildung Mahoneihout palissander gekleurd - Madera de roble pintada palissandro</p> <p>Legno rovere sbiancato - Bleached oak wood Chêne blanchi - Eichenholz, gebleicht Witgemaakt eikenhout - Madera de roble blanqueada</p> <p>Laccati - Lacquered Laque - Lackiert Gelakt - Lacado</p> <p>Laminato alluminio millerighe - Ribbed aluminium laminated Aluminium lamifite milleraies - Lamelliert aluminium Galamineerd aluminium - Laminado aluminio millrayas</p> <p>Melaminico acero - Maple melamine Melamine erable - Melamin mit ahorn Dekor Melamine esdoornhout - Melaminico arce</p> <p>Melaminico rovere naturale - Melamine natural oak wood Chêne naturel melamine - Melamin eiche natur Natuurlijk eikenhout - Melaminico roble natural</p> <p>Melaminico wenghè - Wenghè melamine Melamine wenghè - Melamin- wenghè Wenghè melamine - Melaminico wenghè</p> <p>Melaminico grigio perla - Pearl-grey melamine Melamine gris perle - Melamin in Perlgrau Melamine parelgrijs - Melaminico gris perla</p> <p>Cristallo temperato satinato mm 12 - 12 mm thick tempered satin glass Verre trempée satinée 12 mm - Tempérieres Glas mattier, St. 12 mm Gehard kristal gesatineerd mm 12 - Cristal templado satinado mm 12</p> <p>HPL nero sp. 12 mm - HPL black sp. 12 mm HPL noire sp. 12 mm - HPL schwarz sp. 12 mm HPL zwart sp. 12 mm - HPL negro espesor 12 mm</p> <p>HPL bianco sp. 12 mm - HPL white sp. 12 mm HPL blanc sp. 12 mm - HPL weiss sp. 12 mm HPL wit sp. 12 mm - HPL blanco espesor 12 mm</p>	<p>Frontali e fianchi di chiusura Fronts and closing sides Façades et flancs de fermeture Frontbleden und abschlussflanken Frontstukken en zispanelen Frontales y costados de cierre</p>	<p>Mensole Shelves Consoles Konsolen Opzetstukken Repisas</p>	<p>Piani di lavoro e gambe terminali Work tops and end legs Plateaux de travail et pieds terminaux Arbeitsplatten und end bein Werkbladen en eind poot Planos de trabajo y patas terminales</p>									
	✓	✓	✓	✓	✓	✓	✓	✓	✓	✓	✓	✓
										✓	✓	✓
	✓	✓	✓	✓	✓	✓	✓	✓	✓			

Esempi di componibilità
Modularity example
Exemples modularité
Beispiele der Anbaumöglichkeiten
Voorbeelden voor aanbouw
Ejemplo composición

Dimensioni (cm) Dimensions Dimensions Abmessungen Afmetingen Dimensiones L x P x H	Codice Code Code Nummer Code Código	Prezzo - Price - Prix - Preis - Prijis - Precio									Peso Weight Poids Gewicht Peso Kg	Volume Volume Volume Volumen Volume m³
		Finiture - Finishes - Finitions Ausführungen - Afwerkingen - Acabados										
		CL	PT	RS	GP	RN	AC	GP	RN	AC		
		L			WE			WE				

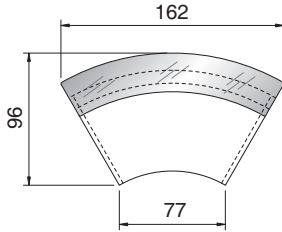

162 x 96 x 110 **YR 1610 01** **2.021** **1.687** **1.507** 98 0.68

Bancone ad 1 elemento, mensole CT
 1-module reception desk, shelves CT
 Comptoir avec 1 Élément, consoles CT
 Rezeptionspult aus 1 Elementen, Konsolen CT
 Bank met 1 elementen, opzetstukken CT
 Mostrador de 1 elemento, repisas CT

Frontale - Front
Façades
Frontbleden
Frontstukken
Frontales
AM

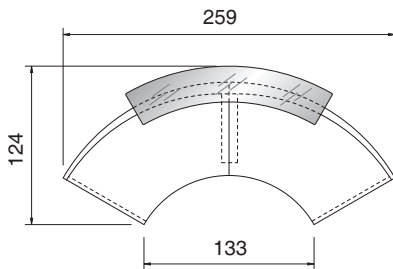

259 x 124 x 110 **YR 2612 02** **3.504** **2.961** **2.601** 159 1.31

Bancone a 2 elementi mensole CT
 2-module reception desk, shelves CT
 Comptoir avec 2 Éléments, consoles CT
 Rezeptionspult aus 2 Elementen, Konsolen CT
 Bank met 2 elementen, opzetstukken CT
 Mostrador de 2 elementos, repisas CT

Frontale - Front
Façades
Frontbleden
Frontstukken
Frontales
AM

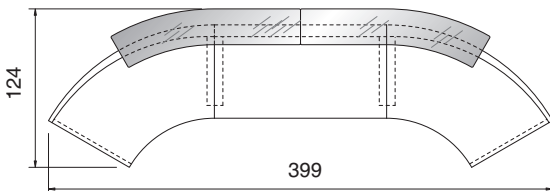

399 x 124 x 110 **YR 4012 03** **4.985** **4.229** **3.709** 242 1.6

Bancone a 3 elementi mensole CT
 3-module reception desk, shelves CT
 Comptoir avec 3 Éléments, consoles CT
 Rezeptionspult aus 3 Elementen, Konsolen CT
 Bank met 3 elementen, opzetstukken CT
 Mostrador de 3 elementos, repisas CT

Frontale - Front
Façades
Frontbleden
Frontstukken
Frontales
AM

Esempi di componibilità
Modularity example
Exemples modularité
Beispiele der Anbaumöglichkeiten
Voorbeelden voor aanbouw
Ejemplo composición

Dimensioni (cm) Dimensions Dimensions Abmessungen Afmetingen Dimensiones L x P x H	Codice Code Code Nummer Code Código	Prezzo - Price - Prix - Preis - Prijs - Precio									Peso Weight Poids Gewicht Peso Kg	Volume Volume Volume Volumen Volume m³
		Finiture - Finishes - Finitions Ausführungen - Afwerkingen - Acabados										
		CL	PT	RS	GP	RN	AC	GP	RN	AC		
		L			WE			WE				

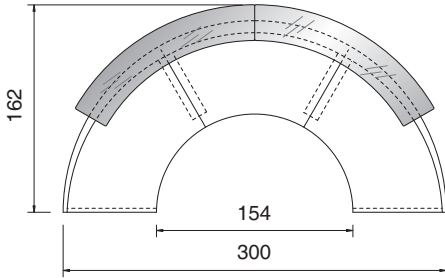

300 x 162 x 110 **YR 3016 03** **5.353** **4.601** **4.061** 246 1.99

Frontale - Front
Façades
Frontbleden
Frontstukken
Frontales
AM

Bancone a 3 elementi mensole CT
 3-module reception desk, shelves CT
 Comptoir avec 3 Éléments, consoles CT
 Rezeptionspult aus 3 Elementen, Konsolen CT
 Bank met 3 elementen, opzetstukken CT
 Mostrador de 3 elementos, repisas CT

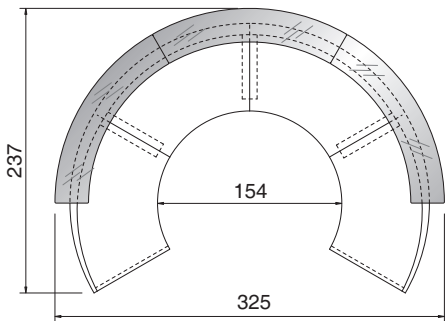

325 x 237 x 110 **YR 3324 04** **7.202** **6.241** **5.521** 333 2.67

Frontale - Front
Façades
Frontbleden
Frontstukken
Frontales
AM

Bancone a 4 elementi mensole CT
 4-module reception desk, shelves CT
 Comptoir avec 4 Éléments, consoles CT
 Rezeptionspult aus 4 Elementen, Konsolen CT
 Bank met 4 elementen, opzetstukken CT
 Mostrador de 4 elementos, repisas CT

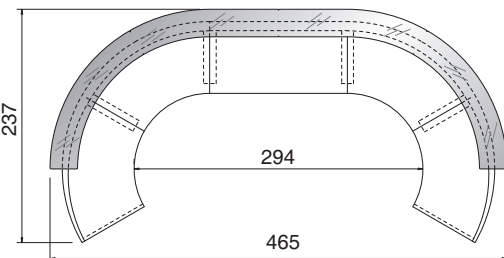

465 x 237 x 110 **YR 4724 05** **8.683** **7.509** **6.629** 416 2.96

Frontale - Front
Façades
Frontbleden
Frontstukken
Frontales
AM

Bancone a 5 elementi mensole CT
 5-module reception desk, shelves CT
 Comptoir avec 5 Éléments, consoles CT
 Rezeptionspult aus 5 Elementen, Konsolen CT
 Bank met 5 elementen, opzetstukken CT
 Mostrador de 5 elementos, repisas CT

Esempi di componibilità
Modularity example
Exemples modularité
Beispiele der Anbaumöglichkeiten
Voorbeelden voor aanbouw
Ejemplo composición

Dimensioni (cm) Dimensions Dimensions Abmessungen Afmetingen Dimensiones L x P x H	Codice Code Code Nummer Code Código	Prezzo - Price - Prix - Preis - Prijs - Precio									Peso Weight Poids Gewicht Peso Kg	Volume Volume Volume Volumen Volume m³
		Finiture - Finishes - Finitions Ausführungen - Afwerkingen - Acabados			GP RN AC			GP RN AC				
		CL	PT	RS	GP	RN	AC	GP	RN	AC		
		L			WE			WE				

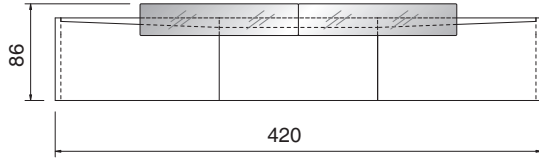

420 x 86 x 110 **YR 4309 03** **4.015** **3.251** **2.771** 234 0.78

Bancone a 3 elementi mensole CT
 3-module reception desk, shelves CT
 Comptoir avec 3 Éléments, consoles CT
 Rezeptionspult aus 3 Elementen, Konsolen CT
 Bank met 3 elementen, opzetstukken CT
 Mostrador de 3 elementos, repisas CT

Frontale - Front
Façades
Frontbleden
Frontstukken
Frontales
AM

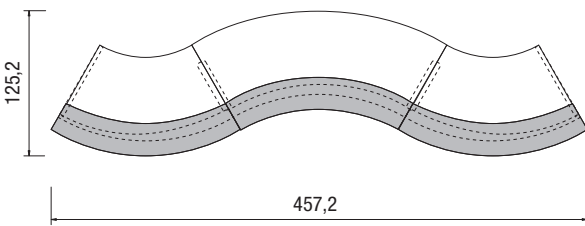

457.2 x 125.2 x 110 **YR 4512 00** **5.815** **5.017** **4.477** 286 2.12

Bancone a 2 elementi concavi e 1 convesso, mensole CT
 Reception desk with 1 convex and 2 concave modules, shelves CT
 Comptoir à 2 éléments concaves et 1 convexe, consoles CT
 Rezeptionspult mit 2 nach innen gewölbten und 1 nach außen gewölbtem Element, Konsolen CT
 Toonbank met 1 convex en 2 concave elementen, CT-legplank
 Mostrador de 2 elementos cóncavos y 1 convexo, repisas CT

Frontale - Front
Façades
Frontbleden
Frontstukken
Frontales
AM

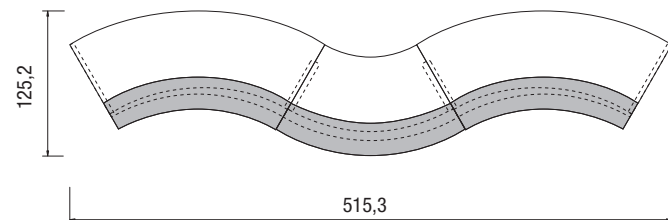

515.3 x 125.2 x 100 **YR 5112 00** **5.913** **5.069** **4.529** 300 2.2

Bancone a 1 elemento concavo e 2 convessi, mensole CT
 Reception desk with 1 concave and 2 convex modules, shelves CT
 Comptoir à 1 élément concave et 2 convexas, consoles CT
 Rezeptionspult mit 1 nach innen gewölbten und 2 nach außen gewölbten Elementen, Konsolen CT
 Toonbank met 1 concaaf en 2 convexe elementen, CT- legplank
 Mostrador de 1 elemento cóncavo y 2 convexos, repisas CT

Frontale - Front
Façades
Frontbleden
Frontstukken
Frontales
AM

Esempi di componibilità
Modularity example
Exemples modularité
Beispiele der Anbaumöglichkeiten
Voorbeelden voor aanbouw
Ejemplo composición

Dimensioni (cm) Dimensions Dimensions Abmessungen Afmetingen Dimensiones L x P x H	Codice Code Code Nummer Code Código	Prezzo - Price - Prix - Preis - Prijs - Precio									Peso Weight Poids Gewicht Peso Kg	Volume Volume Volume Volumen Volume m³
		Finiture - Finishes - Finitions Ausführungen - Afwerkingen - Acabados										
		CL	PT	RS	GP	RN	AC	GP	RN	AC		
		L			WE			WE				

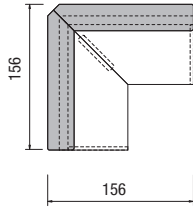

156 x 156 x 110 **YR 1515 00** **2.814** **2.263** **1.943** 171 0.55

Bancone con 1 angolo 90° dx-sx, mensole CT
 Reception desk with LH-RH 90° corner, shelves CT
 Comptoir avec un angle à 90° droite-gauche, consoles CT
 Rezeptionspult mit 1 90°-Winkel RE-LI, Konsolen CT
 Toonbank met 1 90°-hoek, rechts-links, CT- legplank
 Mostrador con 1 ángulo 90° derecha-izquierda, repisas CT

Frontale - Front
Façades
Frontbleden
Frontstukken
Frontales
AM

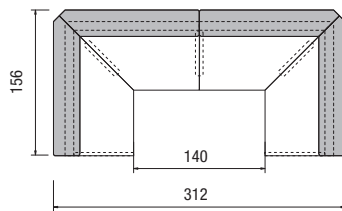

312 x 156 x 110 **YR 3115 00** **5.456** **4.479** **3.839** 331 1.1

Bancone con 2 angoli 90°, mensole CT
 Reception desk with two 90° corners, shelves CT
 Comptoir avec deux angles à 90°, consoles CT
 Rezeptionspult mit 2 90°-Winkeln, Konsolen CT
 Toonbank met 2 90°-hoeken, CT- legplank
 Mostrador con 2 ángulos 90°, repisas CT.

Frontale - Front
Façades
Frontbleden
Frontstukken
Frontales
AM

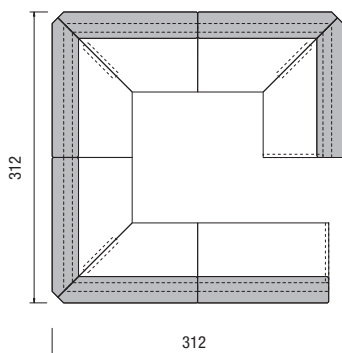

312 x 312 x 110 **YR 3131 00** **9.456** **7.840** **6.720** 572 1.92

Bancone a 4 elementi, mensole CT
 4-module reception desk, shelves CT
 Comptoir avec 4 Éléments, consoles CT
 Rezeptionspult aus 4 Elementen, Konsolen CT
 Bank met 4 elementen, opzetstukken CT
 Mostrador de 4 elementos, repisas CT

Frontale - Front
Façades
Frontbleden
Frontstukken
Frontales
AM

Accessori
Accessories
Accessoires
Zubehöre
Accessoires
Accesorios

Dimensioni (cm) Dimensions Dimensions Abmessungen Afmetingen Dimensiones L x P x H	Codice Code Code Nummer Code Código	Prezzo - Price - Prix - Preis - Prijs - Precio			Peso Weight Poids Gewicht Peso Kg	Volume Volume Volume Volumen Volume m³
		Finiture - Finishes - Finitions Ausführungen - Afwerkingen - Acabados				
		□	□	□		

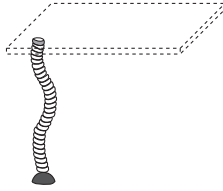

8 x 4 x 72 **BZ 0072 00 AP** **38** 1 0.01

Spirale salita cavi
 Cable up-routing spiral
 Spirale montee cables
 Am schreibetisch
 Kabelspiraal onder het werkblad aan de rand
 Espiral de subida cables



65 x 7 x 1.4 **CZ 0065 00 AP** **16** 1 0.01

Canalina di salita e passaggio cavi
 Duct for upward routing and passage of cables
 Canalisatation de remontée et passage câbles
 Kabelhalterungen und Kabelführungen
 Kanaaltje en kabelgeleiding
 Canal de subida y de paso de los cables

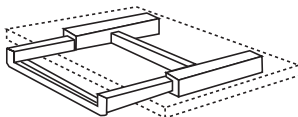

66 x 33 x 6 **CZ 0013 00 00** **77** 2 0.02

Portatastiera estraibile (interno cm 56 x 27)
 Pull - out keyboard carrier (interior: 56 x 27 cm)
 Support telescopique clavier (interieur 56 x 27 cm)
 Auszieh-tastaturbrett (innen 56 x 27 cm)
 Uitschuifb Tussenonderstel (intern 56 x 27 cm)
 Portateclado extraíble (interior cm. 56 x 27)

Accessori
Accessories
Accessories
Zubehöre
Accessoires
Accesorios

Dimensioni (cm) Dimensions Dimensions Abmessungen Afmetingen Dimensiones L x P x H	Codice Code Code Nummer Code Código	Prezzo - Price - Prix - Preis - Prijs - Precio									Peso Weight Poids Gewicht Peso Kg	Volume Volume Volume Volumen Volume Volumen m³
		Finiture - Finishes - Finitions Ausführungen - Afwerkingen - Acabados										
		KR										

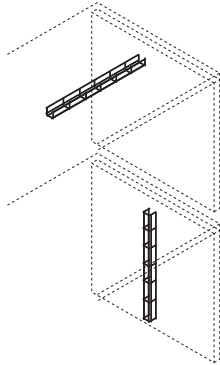

60 x 4 x 4 **CZ 4000 01** **20** 0.3 0.01

Cestello passacavi orizzontale e/o verticale
 Horizontal and/or vertical wire cable tray
 Chemin de câbles horizontal et/ou vertical
 Korbführung als horizontaler und/oder vertikaler Kabeldurchlass
 Horizontale en/of Verticale kabelgeleider
 Cesta pasacables horizontales y/o vertical

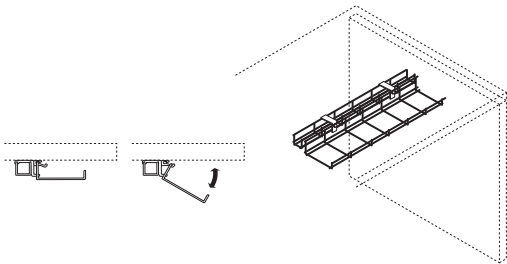

60.4 x 14 x 5.5 **CZ 6000 02** **43** 2.3 0.02

Cestelli portacavi ruotabile ed ispezionabile (con attacchi)
 Cables holder baskets rolling and inspectionable (with attacks)
 Bac porte-cables roulant et inspectionable (avec attaches)
 Kabel halterkörbchen schwenk-und einsehbar mit anschlüssen
 Draaibare en controleerbare korfjes voor elektrische bedrading met contractpunten
 Cestos portaenchufes que se vuelta e inspeccionar (con uniones)