

# ***Preisliste Büromöbel Bralco Schränke A100***

Stand Juli 2008

***e@sy- working***

*Italienische Büromöbel*

*Uwe Heckmann*

*Helene-Weber-Str. 3A*

*D-48527 Nordhorn*

*Telefon: 05921-179 10 72*

*Fax: 01805 - 006534 2613*

*www.easyworking.org*

*info@easyworking.org*

**Finiture e colori**  
**Finishing and colors**  
**Finitions et couleurs**  
**Oberfläche und Farbpalette**  
**Afwerking en kleur**  
**Acabados y colores**

Versione struttura Structure Coque Korpuse Estructura Estructura	AL	CL	PT	NT	LK	LS	LO	LB	LN	LA	LR	LP	LZ	LV	LT	LG
Melaminico alluminio - Aluminium melamine Melamine Aluminium - Melamin Aluminium Melamine Aluminium - Melaminico aluminio	✓															
Legno ciliegio - Cherry wood Cersier - Kirschbaumholz Kersenhout - Madera cerezo		✓														
Legno mogano tinto palissandro - Palisander stained mahogany wood Acajou teinté palissandre - Mahagoniholz, Palisander Mahoniehout palissander gekleurd - Madera de roble pintada palissandro			✓													
Legno Noce - Walnut wood Noyer - Nussbaumholz Notenhout - Madera nogal				✓												
Laccato Kaki - Kaki lacquered Laqué kaki - Kaki lackiert Kaki gelakt - Lacado Kaki					✓											
Laccato smoke - Smoke lacquered Laqué smoke - Smoke lackiert Smoke gelakt - Lacado smoke						✓										
Laccato ardesia - Slate-grey lacquered Laqué ardoise - Schiefergrau lackiert Leikleurig gelakt - Lacado pizarra							✓									
Laccato bianco - White lacquered Laqué blanc - Weiß lackiert Wit gelakt - Lacado blanco								✓								
Laccato nero - Black lacquered Laqué noir - Schwarzlackiert Zwart gelakt - Lacado negro									✓							
Laccato alluminio - Aluminium lacquered Laqué aluminium - Aluminium lackiert Aluminium gelakt - Lacado aluminio										✓						
Laccato bordeaux - Bordeaux lacquered Laqué bordeaux - Bordeaux lackiert Gelakt bordeau - Lacado burdeos											✓					
Laccato rosso papavero - Poppy red lacquered Laqué rouge coquelicot - Mohrrot lackiert Papaverrood gelakt - Lacado rojo amapola												✓				
Laccato azzurro - Blue lacquered Laqué blue chair - Azurblau lackiert Azuur gelakt - Lacado azul													✓			
Laccato verde limone - Lemon green lacquered Laqué citron vert - Limonengrün lackiert Citroengroen gelakt - Lacado verde limón														✓		
Laccato blu notte - Midnight blue lacquered Laqué bleu nuit - Nachtblau lackiert Zwartblauw gelakt - Lacado azul noche															✓	
Laccato arancio - Orange lacquered Laqué orange - Orange lackiert Oranje gelakt - Lacado aranjado																✓

Struttura melaminico  
Melamine structure  
Coque en melamine  
Korpuse Melamin  
Estructura melamine  
Estructura melaminico

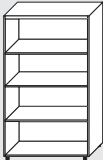

**AM**

Esempio codice  
Example code  
Exemple code  
Beispiel nummer  
Voorbeeld code  
Ejemplo código:  
**AM XXXX XX**

Struttura legno  
Wood structure  
Coque en bois  
Korpuse Holz  
Estructura hout  
Estructura madera

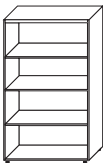

**AL**

Esempio codice  
Example code  
Exemple code  
Beispiel nummer  
Voorbeeld code  
Ejemplo código:  
**AL XXXX XX**

**Finiture e colori**  
**Finishing and colors**  
**Finitions et couleurs**  
**Oberfläche und Farbpalette**  
**Afwerking en kleur**  
**Acabados y colores**

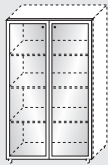
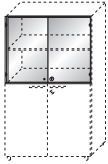
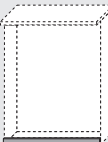
	CT	CN	CR	CV	CM	CB	CC	CA	VG	AF
<p>Cristallo temperato satinato - Tempered glass satin            Verre trempé satiné - Temptiertes Glas mattier            Gehard kristal gesatineerd - Cristal templado satinado</p> <p>Cristallo temperato nero - Black tempered glass            Noir verre trempé - Temptiertes Glas schwarz            Gehard kristal zwart - Cristal templado negro</p> <p>Cristallo temperato bordeaux - Bordeaux tempered glass            Verre trempé bordeaux - Bordeaux Temptiertes Glas            Gehard kristal bordeau - Cristal templado burdeos</p> <p>Cristallo temperato verde petrolio (RAL7016) - Oil green tempered glass (RAL7016)            Verre trempé bleu pétrol (RAL7016) - Petroltemgrün - Temptiertes Glas (RAL7016)            Gehard kristal petroleumgroen (RAL7016) - Cristal templado verde petróleo</p> <p>Cristallo temperato moka (RAL 9016) - Moka tempered glass (RAL 9016)            Verre trempé moka (RAL 9016) - Mokka Temptiertes Glas (RAL 9016)            Gehard kristal mokka (RAL9016) - Cristal templado moka (RAL 9016)</p> <p>Cristallo temperato bianco - White tempered glass satin            Verre trempé blanc - Temptiertes Glas weiß            Gehard kristal wit - Cristal templado blanco</p> <p>Cristallo temperato bleu cobalto (RAL 5013) - Cobalt-blue tempered glass (RAL 5013)            Verre trempé bleu de cobalt (RAL 5013) - Kobalt blau Temptiertes Glas (RAL 5013)            Gehard kristal kobaltblauw (RAL-5013) - Cristal templado azul cobalto (RAL 5013)</p> <p>Cristallo temperato arancio (RAL 2004) - Orange tempered glass (RAL 2004)            Verre trempé orange (RAL 2004) - Orange Temptiertes Glas (RAL 2004)            Gehard kristal oranje (ral 2004) - Cristal templado anaranjado (RAL 2004)</p> <p>Vetro grigio sp. 5 mm. (temperato) - 5 mm thick grey glass (tempered)            Verre gris ép. 5 mm. (trempé) - Graues Glas, St. 5 mm (temperiert)            Grijs glas dikte 5 mm. (gehard) - Vidrio gris espesor 5 mm. (templado)</p> <p>Verniciato epox alluminio - Aluminium epoxy painted            Peint epoxy aluminium - Pulverbeschichtung aluminium            Epox-gevend aluminium - Pintado epoxidico aluminio</p>	<p><b>C_</b></p>									
<p>Ante vetro con telaio alluminio            Glass door with aluminium frame            Portes en verre avec châssis en aluminium            Türen Glas mit Aluminiumrahmen            Glazen deurtjes met aluminium frame            Puertas de vidrio con bastidor de aluminio</p> 	✓	✓	✓	✓	✓	✓	✓	✓		
<p>Ante vetro grigio            Grey glass doors            Portes verre gris            Türen mit einsatz aus grauem glas            Grijze glazen deurtjes            Puertas de vidrio gris</p> 									✓	
<p>Zoccoli            Plinths            Plinthes            Sockel            Plinten            Zócalos</p> 										✓

**Finiture e colori**  
**Finishing and colors**  
**Finitions et couleurs**  
**Oberfläche und ferbpalette**  
**Afwerking en kleur**  
**Acabados y colores**

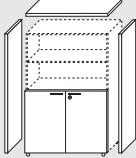
<p>Ante, tops e fianchi di chiusura  Doors, tops and closing sides  Portes, tops et flancs de  fermeture  Türen, platten und  abschlussflanken  Deur top en zijpanelen  Puertas, partes superiores y  costados de cierre</p> 	L.	CL	PT	RS	AM	NT	BL	RN	WE	GP	AC	
	Laccati - Lacquered Laqué - Lackiert Gelakt - Lacado	Legno ciliegio - Cherry wood Cersier - Kirschbaumholz Kersenhout - Madera cerezo	Legno mogano tinto palissandro - Palissander stained mahogany wood Acajou teinté palissandre - Mähagoniholz, Palissander Nachbildung Mahoniehout palissander gekleurd - Madera de roble pintada palissandro	Legno rovere sbiancato - Bleached oak wood Chêne blanchi - Eichenholz, gebleicht Witgemaakt eikenhout - Madera de roble blanqueada	Laminato alluminio millerighe - Ribbed aluminium laminated Aluminium lamifié millerighe - Lamelliert aluminium Galatineerd aluminium - Laminado aluminio millrayas	Legno Noce - Walnut wood Noyer - Nussbaumholz Notenhout - Madera de nogal	Melaminico Bianco - Melamine white Blanc melamine - Melamin Weiß Wit melamine - Melaminico blanco	Melaminico rovere naturale - Melamine natural oak wood Chêne naturel melamine - Melamin eiche natur Natuurlijk eikenhout - Melaminico roble natural	Melaminico wenghè - Wenghè melamine Melamine wenghè - Melamin- wenghè Wenghè melamine - Melaminico wenghe	Melaminico grigio perla - Pearl-grey melamine Melamine gris perle - Melamin in Perlegrau Melamine parelgrijs - Melaminico gris perla	Melaminico acero - Maple wood melamine Melamine Érable - Melamin mit Ahorndekor Melamine esdoornhout - Melaminico arce	

**Armadi H. 81**  
**Cabinets**  
**Armoires**  
**Schränke**  
**Kasten**  
**Armarios**

Dimensioni (cm) Dimensions Dimensions Abmessungen Afmetingen Dimensiones <b>L x P x H</b>	Codice Code Code Nummer Code Código	Prezzo - Price - Prix - Preis - Prijs - Precio												Peso Weight Poids Gewicht Peso <b>Kg</b>	Volume Volume Volume Volumen Volume Volumen <b>m³</b>
		Finiture - Finishes - Finitions Ausführungen - Afwerkingen - Acabados													
		CL	PT	L	RS			NT			RN	WE	GP		

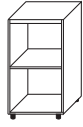

50 x 44 x 81	<b>AM 0508 00 AL</b>													<b>90</b>	21	0.05
--------------	----------------------	--	--	--	--	--	--	--	--	--	--	--	--	-----------	----	------

Armadio con 1 ripiano  
 Cabinet with 1 shelf  
 Armoire avec 1 etagere  
 Schrank mit 1 ablagefach  
 Kast met 1 legplank  
 Armario con 1 anaquel

50 x 44 x 81	<b>AL 0508 00</b>	<b>242</b>	-	<b>213</b>	-									23	0.05
--------------	-------------------	------------	---	------------	---	--	--	--	--	--	--	--	--	----	------



50 x 46 x 81	<b>AM 0508 AD</b>	<b>222</b>	<b>222</b>	<b>204</b>	<b>133</b>									26	0.07
--------------	-------------------	------------	------------	------------	------------	--	--	--	--	--	--	--	--	----	------

Armadio con 1 ripiano e serratura  
 Cabinet with 1 shelf and lock  
 Armoire avec 1 etagere et serrure  
 Schrank mit 1 ablagefach und schloss  
 Kast met 1 legplank en slot  
 Armario con 1 estante y cerradura

50 x 46 x 81	<b>AL 0508 AD</b>	<b>374</b>	-	<b>327</b>	-									28	0.07
--------------	-------------------	------------	---	------------	---	--	--	--	--	--	--	--	--	----	------



50 x 46 x 81	<b>AM 0508 AS</b>	<b>222</b>	<b>222</b>	<b>204</b>	<b>133</b>									26	0.07
--------------	-------------------	------------	------------	------------	------------	--	--	--	--	--	--	--	--	----	------

Armadio con 1 ripiano e serratura  
 Cabinet with 1 shelf and lock  
 Armoire avec 1 etagere et serrure  
 Schrank mit 1 ablagefach und schloss  
 Kast met 1 legplank en slot  
 Armario con 1 estante y cerradura

50 x 46 x 81	<b>AL 0508 AS</b>	<b>374</b>	-	<b>327</b>	-									28	0.07
--------------	-------------------	------------	---	------------	---	--	--	--	--	--	--	--	--	----	------



50 x 46 x 81	<b>AM 0508 BD VG</b>												<b>161</b>	29	0.09
--------------	----------------------	--	--	--	--	--	--	--	--	--	--	--	------------	----	------

Armadio vetro VG con 1 ripiano e serratura dx/sx  
 Cabinet VG glass with 1 shelf and lock rh/lh  
 Armoire vitre VG avec 1 etagere et serrure droit/gauche  
 Schrank mit glasstur VG mit 1 ablagefach und schloss re/li  
 Kast glas VG met 1 legplank en slot re/li  
 Armario vidrio vg con 1 estante y cerradura derecha/izquierda

50 x 46 x 81	<b>AL 0508 BD VG</b>	<b>313</b>	-	<b>284</b>	-									31	0.09
--------------	----------------------	------------	---	------------	---	--	--	--	--	--	--	--	--	----	------

**Armadi H. 81**  
**Cabinets**  
**Armoires**  
**Schränke**  
**Kasten**  
**Armarios**

Dimensioni (cm) Dimensions Dimensions Abmessungen Afmetingen Dimensiones <b>L x P x H</b>	Codice Code Code Nummer Code Código	Prezzo - Price - Prix - Preis - Prijs - Precio												Peso Weight Poids Gewicht Peso <b>Kg</b>	Volume Volume Volume Volumen Volume <b>m³</b>
		Finiture - Finishes - Finitions Ausführungen - Afwerkingen - Acabados													
		CL	PT	L	RS			NT			RN	WE	GP		



100 x 44 x 81	<b>AM 1008 00 AL</b>													32	0.09
---------------	----------------------	--	--	--	--	--	--	--	--	--	--	--	--	----	------

Armadio con 1 ripiano

Cabinet with 1 shelf

Armoire avec 1 etagere

Schrank mit 1 Ablagefach

Kast met 1 legplank

Armario con 1 anaquel

100 x 44 x 81	<b>AL 1008 00</b>	<b>339</b>	-	<b>294</b>	-								36	0.09
---------------	-------------------	------------	---	------------	---	--	--	--	--	--	--	--	----	------



100 x 46 x 81	<b>AM 1008 A0</b>	<b>345</b>	<b>345</b>	<b>312</b>	<b>186</b>								42	0.14
---------------	-------------------	------------	------------	------------	------------	--	--	--	--	--	--	--	----	------

Armadio con 1 ripiano e serratura

Cabinet with 1 shelf and lock

Armoire avec 1 etagere et serrure

Schrank mit 1 Ablagefach und schloss

Kast met 1 legplank en slot

Armario con 1 estante y cerradura

100 x 46 x 81	<b>AL 1008 A0</b>	<b>569</b>	-	<b>491</b>	-								46	0.14
---------------	-------------------	------------	---	------------	---	--	--	--	--	--	--	--	----	------



Non disponibile in CL - PT  
 Not available in CL - PT  
 Pas disponible en CL - PT  
 Nicht vorhanden im CL - PT  
 Niet beschikbaar in CL - PT

Armadio con 1 serratura  
 (cartelle 2 x cm. 33 oppure 2 x cm. 39)

Cabinet with 1 lock  
 (files: 2 x 33 cm or 2 x 39 cm)

Armoire avec 1 serrure  
 (dossiers 2 x 33 cm ou 2 x 39 cm)

Schrank mit 1 schloss  
 (register 2 x 33 cm oder 2 x 39 cm)

Kast met 1 slot  
 (mappen 2 x 33 cm of 2 x 39 cm)

Armario con 1 cerradura  
 (carpetas 2 x cm. 33 o bien 2 x cm. 39)

100 x 46 x 81	<b>AM 1008 B0</b>	<b>502</b>	-	-	<b>394</b>								48	0.21
---------------	-------------------	------------	---	---	------------	--	--	--	--	--	--	--	----	------

100 x 46 x 81	<b>AL 1008 B0</b>	<b>689</b>	-	-	<b>581</b>								51	0.21
---------------	-------------------	------------	---	---	------------	--	--	--	--	--	--	--	----	------



100 x 46 x 81	<b>AM 1008 CO VG</b>												42	0.12
---------------	----------------------	--	--	--	--	--	--	--	--	--	--	--	----	------

Armadio vetro VG con 1 ripiano e serratura

Cabinet VG glass with 1 shelf and lock

Armoire vitre VG avec 1 etagere et serrure

Schrank mit glasstur VG mit 1 Ablagefach und schloss

Kast glas VG met 1 legplank en slot  
 Armario vidrio vg con 1 estante y cerradura

100 x 46 x 81	<b>AL 1008 CO VG</b>	<b>468</b>	-	<b>423</b>	-								46	0.12
---------------	----------------------	------------	---	------------	---	--	--	--	--	--	--	--	----	------

**Armadi H. 120**  
**Cabinets**  
**Armoires**  
**Schränke**  
**Kasten**  
**Armarios**

Dimensioni (cm) Dimensions Dimensions Abmessungen Afmetingen Dimensiones <b>L x P x H</b>	Codice Code Code Nummer Code Código	Prezzo - Price - Prix - Preis - Prijs - Precio										Peso Weight Poids Gewicht Peso <b>Kg</b>	Volume Volume Volume Volumen Volume Volumen <b>m³</b>
		Finiture - Finishes - Finitions Ausführungen - Afwerkingen - Acabados											
		L								RN	WE		

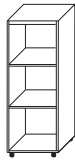

Armadio con 2 ripiani  
 Cabinet with 2 shelves  
 Armoire avec 2 etageres  
 Schrank mit 2 Ablagefächern  
 Kast met 2 legplanken  
 Armario con 2 estantes

50 x 44 x 120	<b>AM 0512 00 AL</b>												<b>134</b>		30	0.07
50 x 44 x 120	<b>AL 0512 00</b>												<b>348</b>	<b>-</b>	30	0.07

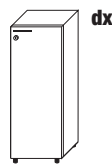

Armadio con 2 ripiani e serratura  
 Cabinet with 2 shelves and lock  
 Armoire avec 2 etageres et serrure  
 Schrank mit 2 Ablagefächern und Schloss  
 Kast met 2 legplanken en slot  
 Armario con 2 estantes y cerradura

50 x 46 x 120	<b>AM 0512 AD</b>												<b>303</b>	<b>187</b>	38	0.1
50 x 46 x 120	<b>AL 0512 AD</b>												<b>517</b>	<b>401</b>	38	0.1

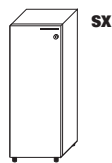

Armadio con 2 ripiani e serratura  
 Cabinet with 2 shelves and lock  
 Armoire avec 2 etageres et serrure  
 Schrank mit 2 Ablagefächern und Schloss  
 Kast met 2 legplanken en slot  
 Armario con 2 estantes y cerradura

50 x 46 x 120	<b>AM 0512 AS</b>												<b>303</b>	<b>187</b>	38	0.1
50 x 46 x 120	<b>AL 0512 AS</b>												<b>517</b>	<b>401</b>	38	0.1



Armadio vetro VG con 2 ripiani e serratura dx/sx  
 Cabinet glass VG with 2 shelves and lock rh/lh  
 Armoire vitre VG avec 2 etageres et serrure dr/ga  
 Schrank mit tur VG mit 2 Ablagefächern und Schloss re/li  
 Kast glas VG met 2 legplanken en slot re/li  
 Armario vidrio VG con 2 estantes y cerradura derecha/izquierda

50 x 46 x 120	<b>AM 0512 BD VG</b>												<b>218</b>		38	0.11
50 x 46 x 120	<b>AL 0512 BD VG</b>												<b>432</b>		38	0.11



Armadio vetro CT con 2 ripiani dx/sx  
 Cabinet glass CT with 2 shelves rh/lh  
 Armoire vitre CT avec 2 etageres dr/ga  
 Schrank mit tur CT mit 2 Ablagefächern re/li  
 Kast glas CT met 2 legplanken re/li  
 Armario vidrio CT con 2 estantes derecha/izquierda

50 x 46 x 120	<b>AM 0512 CO CT</b>												<b>302</b>		38	0.13
50 x 46 x 120	<b>AL 0512 CO CT</b>												<b>516</b>		38	0.13

**Armadi H. 120**  
**Cabinets**  
**Armoires**  
**Schränke**  
**Kasten**  
**Armarios**

Dimensioni (cm) Dimensions Dimensions Abmessungen Afmetingen Dimensiones <b>L x P x H</b>	Codice Code Code Nummer Code Código	Prezzo - Price - Prix - Preis - Prijs - Precio										Peso Weight Poids Gewicht Peso <b>Kg</b>	Volume Volume Volume Volumen Volume Volumen <b>m³</b>
		Finiture - Finishes - Finitions Ausführungen - Afwerkingen - Acabados											
		L						RN	WE	GP	AC		

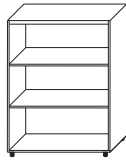

Armadio con 2 ripiani  
 Cabinet with 2 shelves  
 Armoire avec 2 etageres  
 Schrank mit 2 Ablagefächern  
 Kast met 2 legplanken  
 Armario con 2 estantes

100 x 44 x 120	<b>AM 1012 00 AL</b>										<b>172</b>					47	0.1
100 x 44 x 120	<b>AL 1012 00</b>										<b>409</b>			<b>-</b>		49	0.1



Armadio con 2 ripiani e serratura  
 Cabinet with 2 shelves and lock  
 Armoire avec 2 etageres et serrure  
 Schrank mit 2 Ablagefächern und Schloss  
 Kast met 2 legplanken en slot  
 Armario con 2 estantes y cerradura

100 x 46 x 120	<b>AM 1012 A0</b>										<b>476</b>			<b>279</b>		62	0.17
100 x 46 x 120	<b>AL 1012 A0</b>										<b>713</b>			<b>516</b>		64	0.17



Armadio con 1 serratura (cartelle 2 x cm. 33 oppure 2 x cm. 39)  
 Cabinet with 1 lock (files: 2 x 33 cm or 2 x 39 cm)  
 Armoire avec 1 serrure (dossiers 2 x 33 cm ou 2 x 39 cm)  
 Schrank mit 1 Schloss (register 2 x 33 cm oder 2 x 39 cm)  
 Kast met 1 slot (mappen 2 x 33 cm of 2 x 39 cm)  
 Armario con 1 cerradura (carpetas 2 x cm. 33 o bien 2 x cm. 39)

100 x 46 x 120	<b>AM 1012 B0</b>										<b>721</b>			<b>593</b>		67	0.26
100 x 46 x 120	<b>AL 1012 B0</b>										<b>885</b>			<b>757</b>		67	0.26



Armadio vetro VG con 2 ripiani e serratura  
 Cabinet glass VG with 2 shelves and lock  
 Armoire vitre VG avec 2 etageres et serrure  
 Schrank mit tur VG mit 2 Ablagefächern und Schloss  
 Kast glas VG met 2 legplanken en slot  
 Armario vidrio VG con 2 estantes y cerradura

100 x 46 x 120	<b>AM 1012 C0 VG</b>										<b>324</b>					63	0.14
100 x 46 x 120	<b>AL 1012 C0 VG</b>										<b>561</b>					65	0.14



Armadio vetro CT con 2 ripiani  
 Cabinet glass CT with 2 shelves  
 Armoire vitre CT avec 2 etageres  
 Schrank mit tur CT mit 2 Ablagefächern  
 Kast glas CT met 2 legplanken  
 Armario vidrio CT con 2 estantes

100 x 46 x 120	<b>AM 1012 D0 CT</b>										<b>493</b>					62	0.16
100 x 46 x 120	<b>AL 1012 D0 CT</b>										<b>730</b>					64	0.16

**Armadi H. 158**  
**Cabinets**  
**Armoires**  
**Schränke**  
**Kasten**  
**Armarios**

Dimensioni (cm) Dimensions Dimensions Abmessungen Afmetingen Dimensiones <b>L x P x H</b>	Codice Code Code Nummer Code Código	Prezzo - Price - Prix - Preis - Prijs - Precio												Peso Weight Poids Gewicht Peso <b>Kg</b>	Volume Volume Volume Volume Volume Volume <b>m³</b>
		Finiture - Finishes - Finitions Ausführungen - Afwerkingen - Acabados													
		CL	PT	L	RS			NT			RN	WE	GP		

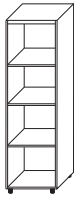

50 x 44 x 158	<b>AM 0516 00 AL</b>												<b>158</b>	40	0.1
---------------	----------------------	--	--	--	--	--	--	--	--	--	--	--	------------	----	-----

Armadio con 2 ripiani mobili e 1 fisso

Cabinet with 2 movable shelves and 1 fixed

Armoire avec 2 étagères mobiles et 1 fixe

Schrank mit 2 beweglichen und 1 festen Einlegboden

Kast met 2 mobiele en 1 vast vlak

Armario con 2 anaqueles móviles y 1 fijo

50 x 44 x 158	<b>AL 0516 00</b>	<b>419</b>	-	<b>358</b>	-								42	0.1
---------------	-------------------	------------	---	------------	---	--	--	--	--	--	--	--	----	-----

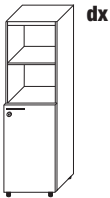

**dx**

50 x 46 x 158	<b>AM 0516 AD</b>	<b>290</b>	<b>290</b>	<b>272</b>	<b>201</b>								45	0.12
---------------	-------------------	------------	------------	------------	------------	--	--	--	--	--	--	--	----	------

Armadio con 2 ripiani mobili e 1 fisso, 1 serratura

Cabinet with 2 movable shelves and 1 fixed, and 1 lock

Armoire avec 2 étagères mobiles et 1 fixe, et 1 serrure

Schrank mit 2 beweglichen und 1 festen Einlegboden, und 1 schloss

Kast met 2 mobiele en 1 vast vlak, en 1 slot

Armario con 2 anaqueles móviles y 1 fijo, y 1 cerradura

50 x 46 x 158	<b>AL 0516 AD</b>	<b>551</b>	-	<b>472</b>	-								47	0.12
---------------	-------------------	------------	---	------------	---	--	--	--	--	--	--	--	----	------



**sx**

50 x 46 x 158	<b>AM 0516 AS</b>	<b>290</b>	<b>290</b>	<b>272</b>	<b>201</b>								45	0.12
---------------	-------------------	------------	------------	------------	------------	--	--	--	--	--	--	--	----	------

Armadio con 2 ripiani mobili e 1 fisso, 1 serratura

Cabinet with 2 movable shelves and 1 fixed, and 1 lock

Armoire avec 2 étagères mobiles et 1 fixe, et 1 serrure

Schrank mit 2 beweglichen und 1 festen Einlegboden, und 1 schloss

Kast met 2 mobiele en 1 vast vlak, en 1 slot

Armario con 2 anaqueles móviles y 1 fijo, y 1 cerradura

50 x 46 x 158	<b>AL 0516 AS</b>	<b>551</b>	-	<b>472</b>	-								45	0.12
---------------	-------------------	------------	---	------------	---	--	--	--	--	--	--	--	----	------



**dx**

50 x 46 x 158	<b>AM 0516 BD</b>	<b>361</b>	<b>361</b>	<b>343</b>	<b>272</b>								53	0.16
---------------	-------------------	------------	------------	------------	------------	--	--	--	--	--	--	--	----	------

50 x 46 x 158	<b>AL 0516 BD</b>	<b>622</b>	-	<b>543</b>	-								55	0.16
---------------	-------------------	------------	---	------------	---	--	--	--	--	--	--	--	----	------

Armadio dx con 2 ripiani mobili e 1 fisso, 1 serratura e anta vetro telaio

Right-hand cabinet with 2 movable shelves and 1 fixed, 1 lock and glass door frame

Armoire droite avec 2 étagères mobiles et 1 fixe, 1 serrure et porte en verre avec châssis

Schrank RE mit 2 beweglichen und 1 festen Einlegboden, 1 Schloss und Glastür mit Rahmen

Rechtste kast met 2 mobiele en 1 vast vlak, 1 slot en glazen ruit lijst

Armario derecho con 2 anaqueles móviles y 1 fijo, 1 cerradura y puerta de vidrio en el bastidor

**Armadi H. 158**  
**Cabinets**  
**Armoires**  
**Schränke**  
**Kasten**  
**Armarios**

Dimensioni (cm) Dimensions Dimensions Abmessungen Afmetingen Dimensiones <b>L x P x H</b>	Codice Code Code Nummer Code Código	Prezzo - Price - Prix - Preis - Prijs - Precio												Peso Weight Poids Gewicht Peso <b>Kg</b>	Volume Volume Volume Volume Volume Volume <b>m³</b>
		Finiture - Finishes - Finitions Ausführungen - Afwerkingen - Acabados													
		CL	PT	L	RS			NT			RN	WE	GP		

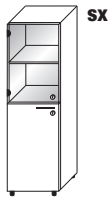

**sx**

50 x 46 x 158	<b>AM 0516 BS</b>	<b>361</b>	<b>361</b>	<b>343</b>	<b>272</b>	53	0.16
50 x 46 x 158	<b>AL 0516 BS</b>	<b>622</b>	<b>-</b>	<b>543</b>	<b>-</b>	55	0.16

Armadio sx con 2 ripiani mobili e 1 fisso, 1 serratura e anta vetro telaio  
 Left-hand cabinet with 2 movable shelves and 1 fixed, 1 lock and glass door frame  
 Armoire gauche avec 2 étagères mobiles et 1 fixe, 1 serrure et porte en verre avec châssis  
 Schrank LI mit 2 beweglichen und 1 festen Einlegboden, 1 Schloss und Glastür mit Rahmen  
 LI kast met 2 mobiele en 1 vast vlak, 1 slot en glazen ruit lijst  
 Armario izquierdo con 2 anaqueles móviles y 1 fijo, 1 cerradura y puerta de vidrio en el bastidor

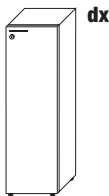

**dx**

50 x 46 x 158	<b>AM 0516 CD</b>	<b>365</b>	<b>365</b>	<b>333</b>	<b>223</b>	50	0.14
50 x 46 x 158	<b>AL 0516 CD</b>	<b>626</b>	<b>-</b>	<b>533</b>	<b>-</b>	52	0.14

Armadio con 2 ripiani mobili e 1 fisso, 1 serratura  
 Cabinet with 2 movable shelves and 1 fixed, 1 lock  
 Armoire avec 2 étagères mobiles et 1 fixe, 1 serrure  
 Schrank mit 2 beweglichen und 1 festen Einlegboden, 1 schloss  
 Kast met 2 mobiele en 1 vast vlak, 1 slot  
 Armario con 2 anaqueles móviles y 1 fijo, 1 cerradura

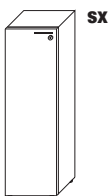

**sx**

50 x 46 x 158	<b>AM 0516 CS</b>	<b>365</b>	<b>365</b>	<b>333</b>	<b>223</b>	50	0.14
50 x 46 x 158	<b>AL 0516 CS</b>	<b>626</b>	<b>-</b>	<b>533</b>	<b>-</b>	52	0.14

Armadio con 2 ripiani mobili e 1 fisso, 1 serratura  
 Cabinet with 2 movable shelves and 1 fixed, 1 lock  
 Armoire avec 2 étagères mobiles et 1 fixe, 1 serrure  
 Schrank mit 2 beweglichen und 1 festen Einlegboden, 1 schloss  
 Kast met 2 mobiele en 1 vast vlak, 1 slot  
 Armario con 2 anaqueles móviles y 1 fijo, 1 cerradura



50 x 46 x 158	<b>AM 0516 DO CT</b>			<b>359</b>		51	0.18
50 x 46 x 158	<b>AL 0516 DO CT</b>	<b>620</b>	<b>-</b>	<b>559</b>	<b>-</b>	53	0.18

Armadio con telaio e vetro CT con 2 ripiani mobili e 1 fisso, 1 serratura  
 Cabinet + frame +CT glass with 2 movable shelves and 1 fixed, 1 lock  
 Arm. cadre et vitre CT avec 2 étagères mobiles et 1 fixe, 1 serrure  
 CT Schrank m. tür mit 2 beweglichen und 1 festen Einlegboden, 1 schloss  
 Kast met frame en CT glas met 2 mobiele en 1 vast vlak, 1 slot  
 Armario con bastidor y vidrio CT con 2 anaqueles móviles y 1 fijo, 1 cerradura

**Armadi H. 158**  
**Cabinets**  
**Armoires**  
**Schränke**  
**Kasten**  
**Armarios**

Dimensioni (cm) Dimensions Dimensions Abmessungen Afmetingen Dimensiones <b>L x P x H</b>	Codice Code Code Nummer Code Código	Prezzo - Price - Prix - Preis - Prijs - Precio												Peso Weight Poids Gewicht Peso <b>Kg</b>	Volume Volume Volume Volumen Volume <b>m³</b>
		Finiture - Finishes - Finitions Ausführungen - Afwerkingen - Acabados													
		CL	PT	L	RS			NT			RN	WE	GP		

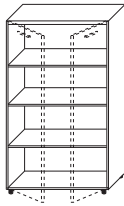

100 x 44 x 158	<b>AM 1016 00 AL</b>												<b>220</b>	61	0.15
100 x 44 x 158	<b>AL 1016 00</b>	<b>607</b>												70	0.15

Armadio **predisposto per anta intera** con 2 ripiani mobili e 1 fisso  
 Cabinet **arranged for entire door** with 2 movable shelves and 1 fixed  
 Armoire **disposé pour porte entière** avec 2 étagères mobiles et 1 fixe  
 Schrank **für ganze tür vorbereitet** mit 2 beweglichen und 1 festen Einlegboden  
 Kast **lever baar met hele deur** met 2 mobiele en 1 vast vlak  
 Armario **preparado para puerta interna** con 2 anaqueles móviles y 1 fijo

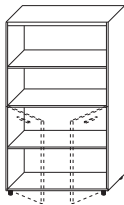

100 x 44 x 158	<b>AM 1016 PI AL</b>												<b>220</b>	61	0.15
100 x 44 x 158	<b>AL 1016 PI</b>	<b>607</b>												70	0.15

Armadio **predisposto per anta bassa** con 2 ripiani mobili e 1 fisso  
 Cabinet **arranged for short door** with 2 movable shelves and 1 fixed  
 Armoire **disposé pour porte basse** avec 2 étagères mobiles et 1 fixe  
 Schrank **für niedrige tür vorbereitet** mit 2 beweglichen und 1 festen Einlegboden  
 Kast **lever baar met lage deur** met 2 mobiele en 1 vast vlak  
 Armario **preparado para puerta baja** con 2 anaqueles móviles y 1 fijo

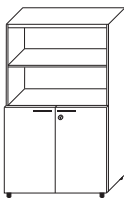

100 x 44 x 158	<b>AM 1016 AO</b>	<b>450</b>												71	0.2
100 x 44 x 158	<b>AL 1016 AO</b>	<b>837</b>												80	0.2

Armadio con 2 ripiani mobili e 1 fisso, 1 serratura  
 Cabinet with 2 movable shelves and 1 fixed, and 1 lock  
 Armoire avec 2 étagères mobiles et 1 fixe, et 1 serrure  
 Schrank mit 2 beweglichen und 1 festen Einlegboden, und 1 schloss  
 Kast met 2 mobiele en 1 vast vlak, en 1 slot  
 Armario con 2 anaqueles móviles y 1 fijo, y 1 cerradura

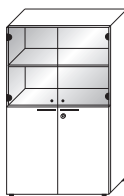

100 x 44 x 158	<b>AM 1016 BO</b>	<b>579</b>												81	0.23
100 x 44 x 158	<b>AL 1016 BO</b>	<b>966</b>												90	0.23

Armadio con anta in vetro VG con 2 ripiani mobili e 1 fisso, 1 serratura  
 Cabinet with VG glass door with 2 movable shelves and 1 fixed, and 1 lock  
 Armoire porte vitree VG avec 2 étagères mobiles et 1 fixe, et 1 serrure  
 Schrank mit VG glastür mit 2 beweglichen und 1 festen Einlegboden, und 1 schloss  
 Kast met VG glazen deur met 2 mobiele en 1 vast vlak, en 1 slot  
 Armario con puerta de vidrio VG con 2 anaqueles móviles y 1 fijo, y 1 cerradura

**Armadi H. 158**  
**Cabinets**  
**Armoires**  
**Schränke**  
**Kasten**  
**Armarios**

Dimensioni (cm) Dimensions Dimensions Abmessungen Afmetingen Dimensiones <b>L x P x H</b>	Codice Code Code Nummer Code Código	Prezzo - Price - Prix - Preis - Prijs - Precio												Peso Weight Poids Gewicht Peso <b>Kg</b>	Volume Volume Volume Volume Volume Peso <b>m³</b>
		Finiture - Finishes - Finitions Ausführungen - Afwerkingen - Acabados													
		CL	PT	L	RS			NT			RN	WE	GP		



100 x 46 x 158	<b>AM 1016 CO</b>	<b>599</b>	<b>599</b>	<b>537</b>	<b>360</b>	81	0.24
----------------	-------------------	------------	------------	------------	------------	----	------

Armadio con 2 ripiani mobili e 1 fisso, 1 serratura  
 Cabinet with 2 movable shelves and 1 fixed, and 1 lock  
 Armoire avec 2 étagères mobiles et 1 fixe, et 1 serrure  
 Schrank mit 2 beweglichen und 1 festen Einlegboden, und 1 schloss  
 Kast met 2 mobiele en 1 vast vlak, en 1 slot  
 Armario con 2 anaqueles móviles y 1 fijo, y 1 cerradura



Non disponibile in CL - PT Not available in CL - PT No disponible en CL - PT Nicht vorhanden im CL - PT Niet beschikbaar in CL - PT							
100 x 46 x 158	<b>AM 1016 EO</b>	<b>608</b>	-	-	<b>500</b>	77	0.28
100 x 46 x 158	<b>AL 1016 EO</b>	<b>959</b>	-	-	<b>851</b>	85	0.28

Armadio con 1 ripiano mobile e 1 fisso, 1 serratura (cartelle 2 x cm. 33 oppure 2 x cm. 39)  
 Cabinet with 1 movable shelf and 1 fixed, 1 lock (files: 2 x 33 cm or 2 x 39 cm)  
 Armoire avec 1 étagère mobiles et 1 fixe, 1 serrure (dossiers 2 x 33 cm ou 2 x 39 cm)  
 Schrank mit 1 beweglichen und 1 festen Einlegboden, 1 schloss (register 2 x 33 cm oder 2 x 39 cm)  
 Kast met 1 mobiele en 1 vast vlak, 1 slot (mappen 2 x 33 cm of 2 x 39 cm)  
 Armario con 1 anaquel móviles y 1 fijo, 1 cerradura (carpetas 2 x cm. 33 o bien 2 x cm. 39)



Non disponibile in CL - PT Not available in CL - PT No disponible en CL - PT Nicht vorhanden im CL - PT Niet beschikbaar in CL - PT							
100 x 46 x 158	<b>AM 1016 FO</b>	<b>737</b>	-	-	<b>629</b>	87	0.31
100 x 46 x 158	<b>AL 1016 FO</b>	<b>1.088</b>	-	-	<b>980</b>	95	0.31

Armadio con ante in vetro VG con 1 ripiano mobile e 1 fisso, 1 serratura (cartelle 2 x cm. 33 oppure 2 x cm. 39)  
 Cabinet with VG glass doors with 1 movable shelf and 1 fixed, 1 lock (files: 2 x 33 cm or 2 x 39 cm)  
 Armoire portes vitrees VG avec 1 étagère mobiles et 1 fixe, 1 serrure (dossiers 2 x 33 cm ou 2 x 39 cm)  
 Schrank mit VG glastür mit 1 beweglichen und 1 festen Einlegboden, 1 schloss (register 2 x 33 cm oder 2 x 39 cm)  
 Kast met VG glazen deuren met 1 mobiele en 1 vast vlak, 1 slot (mappen 2 x 33 cm of 2 x 39 cm)  
 Armario con puertas de vidrio vg con 1 anaquel móviles y 1 fijo, 1 cerraduras (carpetas 2 x cm. 3 o bien 2 x cm. 39)



100 x 46 x 158	<b>AM 1016 GO CT</b>	<b>604</b>				80	0.23
----------------	----------------------	------------	--	--	--	----	------

Armadio con telaio e vetro CT con 2 ripiani mobili e 1 fisso  
 Cabinet + frame +CT glass with 2 movable shelves and 1 fixed  
 Arm. cadre et vitre CT avec 2 étagères mobiles et 1 fixe  
 CT Schrank m. tür mit 2 beweglichen und 1 festen Einlegboden  
 Kast met frame en CT glas met 2 mobiele en 1 vast vlak  
 Armario con bastidor y vidrio CT con 2 anaqueles móviles y 1 fijo

100 x 46 x 158	<b>AL 1016 GO CT</b>	<b>991</b>	-	<b>909</b>	-	89	0.23
----------------	----------------------	------------	---	------------	---	----	------

**Armadi H. 197**  
**Cabinets**  
**Armoires**  
**Schränke**  
**Kasten**  
**Armarios**

Dimensioni (cm) Dimensions Dimensions Abmessungen Afmetingen Dimensiones <b>L x P x H</b>	Codice Code Code Nummer Code Código	Prezzo - Price - Prix - Preis - Prijs - Precio												Peso Weight Poids Gewicht Peso <b>Kg</b>	Volume Volume Volume Volumen Volume Volumen <b>m³</b>	
		Finiture - Finishes - Finitions Ausführungen - Afwerkingen - Acabados														
		CL	PT	L	RS			NT			RN	WE	GP			

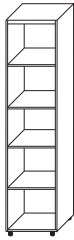

Armadio con 4 ripiani  
 Cabinet with 4 shelves  
 Armoire avec 4 etageres  
 Schrank mit 4 ablagefächern  
 Kast met 4 legplanken  
 Armario con 4 estantes

50 x 44 x 197	<b>AM 0520 00 AL</b>													<b>187</b>	48	0.11
50 x 44 x 197	<b>AL 0520 00</b>	<b>509</b>	-			<b>435</b>	-							51	0.11	

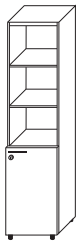

Armadio con 3 ripiani e serratura  
 Cabinet with 3 shelves and lock  
 Armoire avec 3 etageres et serrure  
 Schrank mit 3 ablagefächern und schloss  
 Kast met 3 legplanken en slot  
 Armario con 3 estantes y cerradura

50 x 46 x 197	<b>AM 0520 AD</b>	<b>319</b>	<b>319</b>			<b>301</b>	<b>230</b>							53	0.13
50 x 46 x 197	<b>AL 0520 AD</b>	<b>641</b>	-			<b>549</b>	-							56	0.13



Armadio con 3 ripiani e serratura  
 Cabinet with 3 shelves and lock  
 Armoire avec 3 etageres et serrure  
 Schrank mit 3 ablagefächern und schloss  
 Kast met 3 legplanken en slot  
 Armario con 3 estantes y cerradura

50 x 46 x 197	<b>AM 0520 AS</b>	<b>319</b>	<b>319</b>			<b>301</b>	<b>230</b>							53	0.13
50 x 46 x 197	<b>AL 0520 AS</b>	<b>641</b>	-			<b>549</b>	-							56	0.13

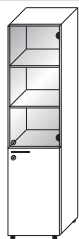

Armadio con anta in vetro VG con 3 ripiani e 2 serrature  
 Cabinet with VG glass door with 3 shelves and 2 locks  
 Armoire porte vitree VG avec 3 etageres et 2 serrures  
 Schrank mit VG glastür mit 3 ablagefächern und 2 schloss  
 Kast met VG glazen deur met 3 legplanken en 2 slot  
 Armario con puerta de vidrio VG con 3 estantes y 2 cerraduras

50 x 46 x 197	<b>AM 0520 BD</b>	<b>403</b>	<b>403</b>			<b>385</b>	<b>314</b>							61	0.17
50 x 46 x 197	<b>AL 0520 BD</b>	<b>725</b>	-			<b>633</b>	-							64	0.17

**Armadi H. 197**  
**Cabinets**  
**Armoires**  
**Schränke**  
**Kasten**  
**Armarios**

Dimensioni (cm) Dimensions Dimensions Abmessungen Afmetingen Dimensiones <b>L x P x H</b>	Codice Code Code Nummer Code Código	Prezzo - Price - Prix - Preis - Prijs - Precio												Peso Weight Poids Gewicht Peso <b>Kg</b>	Volume Volume Volume Volumen Volume Volumen <b>m³</b>	
		Finiture - Finishes - Finitions Ausführungen - Afwerkingen - Acabados														
		CL	PT	L	RS			NT			RN	WE	GP			



**SX**

50 x 46 x 197	<b>AM 0520 BS</b>	<b>403</b>	<b>403</b>	<b>385</b>	<b>314</b>	61	0.17
---------------	-------------------	------------	------------	------------	------------	----	------

Armadio con anta in vetro VG con 3 ripiani e 2 serrature

Cabinet with VG glass door with 3 shelves and 2 locks

Armoire porte vitree VG avec 3 etageres et 2 serrures

Schrank mit VG glastür mit 3 ablagefächern und 2 schloss

Kast met VG glazen deur met 3 legplanken en 2 slot

Armario con puerta de vidrio VG con 3 estantes y 2 cerraduras

50 x 46 x 197	<b>AL 0520 BS</b>	<b>725</b>	<b>-</b>	<b>633</b>	<b>-</b>	64	0.17
---------------	-------------------	------------	----------	------------	----------	----	------

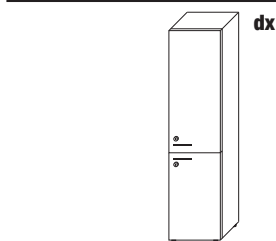

**dx**

Non disponibile in CL - PT  
 Not available in CL - PT  
 No disponible en CL - PT  
 Nicht vorhanden im CL - PT  
 Niet beschikbaar in CL - PT

50 x 46 x 197	<b>AM 0520 CD</b>	<b>488</b>	<b>-</b>	<b>-</b>	<b>283</b>	61	0.16
---------------	-------------------	------------	----------	----------	------------	----	------

Armadio con 3 ripiani e 2 serrature

Cabinet with 3 shelves and 2 locks

Armoire avec 3 etageres et 2 serrures

Schrank mit 3 ablagefächern und 2 schloss

Kast met 3 legplanken en 2 slot

Armario con 3 estantes y 2 cerraduras

50 x 46 x 197	<b>AL 0520 CD</b>	<b>810</b>	<b>-</b>	<b>-</b>	<b>605</b>	64	0.16
---------------	-------------------	------------	----------	----------	------------	----	------

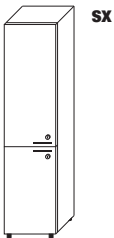

**SX**

Non disponibile in CL - PT  
 Not available in CL - PT  
 No disponible en CL - PT  
 Nicht vorhanden im CL - PT  
 Niet beschikbaar in CL - PT

50 x 46 x 197	<b>AM 0520 CS</b>	<b>488</b>	<b>-</b>	<b>-</b>	<b>283</b>	61	0.16
---------------	-------------------	------------	----------	----------	------------	----	------

Armadio con 3 ripiani e 2 serrature

Cabinet with 3 shelves and 2 locks

Armoire avec 3 etageres et 2 serrures

Schrank mit 3 ablagefächern und 2 schloss

Kast met 3 legplanken en 2 slot

Armario con 3 estantes y 2 cerraduras

50 x 46 x 197	<b>AL 0520 CS</b>	<b>810</b>	<b>-</b>	<b>-</b>	<b>605</b>	64	0.16
---------------	-------------------	------------	----------	----------	------------	----	------

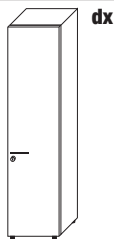

**dx**

50 x 46 x 197	<b>AM 0520 ED</b>	<b>438</b>	<b>438</b>	<b>400</b>	<b>264</b>	61	0.16
---------------	-------------------	------------	------------	------------	------------	----	------

Armadio con 4 ripiani e serratura

Cabinet with 4 shelves and lock

Armoire avec 4 etageres et serrure

Schrank mit 4 ablagefächern und schloss

Kast met 4 legplanken en slot

Armario con 4 estantes y cerradura

50 x 46 x 197	<b>AL 0520 ED</b>	<b>760</b>	<b>-</b>	<b>648</b>	<b>-</b>	64	0.16
---------------	-------------------	------------	----------	------------	----------	----	------

**Armadi H. 197**  
**Cabinets**  
**Armoires**  
**Schränke**  
**Kasten**  
**Armarios**

Dimensioni (cm) Dimensions Dimensions Abmessungen Afmetingen Dimensiones <b>L x P x H</b>	Codice Code Code Nummer Code Código	Prezzo - Price - Prix - Preis - Prijs - Precio												Peso Weight Poids Gewicht Peso <b>Kg</b>	Volume Volume Volume Volumen Volume Volumen <b>m³</b>
		Finiture - Finishes - Finitions Ausführungen - Afwerkingen - Acabados													
		CL	PT	L	RS			NT			RN	WE	GP		

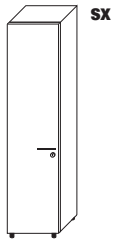

Armadio con 4 ripiani e serratura  
 Cabinet with 4 shelves and lock  
 Armoire avec 4 etageres et serrure  
 Schrank mit 4 ablagefächern und schloss  
 Kast met 4 legplanken en slot  
 Armario con 4 estantes y cerradura

50 x 46 x 197	<b>AM 0520 ES</b>	<b>438</b>	<b>438</b>	<b>400</b>	<b>264</b>	61	0.16
50 x 46 x 197	<b>AL 0520 ES</b>	<b>760</b>	-	<b>648</b>	-	64	0.16

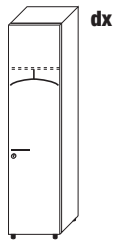

Armadio appendiabiti con 1 ripiano fisso, riloga e serratura  
 Clothes-hanger cabinet with 1 movable shelf, rail and lock  
 Penderie avec 1 étagère mobiles, tringle et serrure  
 Garderobeschrank mit 1 ablagefach und schloss  
 Hangkast met 1 legplank mobiele en slot  
 Armario con percha, 1 anaquel móviles y cerradura

50 x 46 x 197	<b>AM 0520 LD</b>	<b>417</b>	<b>417</b>	<b>379</b>	<b>243</b>	51	0.15
50 x 46 x 197	<b>AL 0520 LD</b>	<b>684</b>	-	<b>586</b>	-	53	0.15

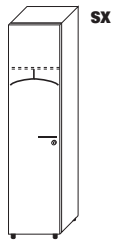

Armadio appendiabiti con 1 ripiano fisso, riloga e serratura  
 Clothes-hanger cabinet with 1 movable shelf, rail and lock  
 Penderie avec 1 étagère mobiles, tringle et serrure  
 Garderobeschrank mit 1 ablagefach und schloss  
 Hangkast met 1 legplank mobiele en slot  
 Armario con percha, 1 anaquel móviles y cerradura

50 x 46 x 197	<b>AM 0520 LS</b>	<b>417</b>	<b>417</b>	<b>379</b>	<b>243</b>	51	0.15
50 x 46 x 197	<b>AL 0520 LS</b>	<b>684</b>	-	<b>586</b>	-	53	0.15

**Armadi H. 197**  
**Cabinets**  
**Armoires**  
**Schränke**  
**Kasten**  
**Armarios**

Dimensioni (cm) Dimensions Dimensions Abmessungen Afmetingen Dimensiones <b>L x P x H</b>	Codice Code Code Nummer Code Código	Prezzo - Price - Prix - Preis - Prijs - Precio												Peso Weight Poids Gewicht Peso <b>Kg</b>	Volume Volume Volume Volumen Volume Volumen <b>m³</b>
		Finiture - Finishes - Finitions Ausführungen - Afwerkingen - Acabados													
		CL	PT	L	RS			NT			RN	WE	GP		

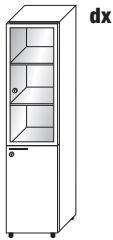

**dx**

50 x 46 x 197	<b>AM 0520 GD</b>	<b>487</b>	<b>487</b>	<b>469</b>	<b>398</b>	61	0.19
---------------	-------------------	------------	------------	------------	------------	----	------

Armadio con anta in vetro CT con 3 ripiani mobili e serratura 50 x 46 x 197 **AL 0520 GD** **809** - **717** - - 64 0.19  
 Cabinet with CT glass door with 3 movable shelves and lock  
 Armoire porte vitree CT avec 3 étagères mobiles et serrure  
 Schrank mit CT glastür mit 3 ablagefachern und schloss  
 Kast met CT glazen deur met 3 legplanken mobiele en slot  
 Armario con puerta de vidrio CT con 3 anaqueles móviles y cerradura

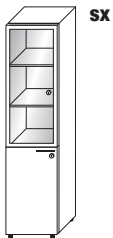

**sx**

50 x 46 x 197	<b>AM 0520 GS</b>	<b>487</b>	<b>487</b>	<b>469</b>	<b>398</b>	61	0.19
---------------	-------------------	------------	------------	------------	------------	----	------

Armadio con anta in vetro CT con 3 ripiani mobili e serratura 50 x 46 x 197 **AL 0520 GS** **809** - **717** - - 64 0.19  
 Cabinet with CT glass door with 3 movable shelves and lock  
 Armoire porte vitree CT avec 3 étagères mobiles et serrure  
 Schrank mit CT glastür mit 3 ablagefachern und schloss  
 Kast met CT glazen deur met 3 legplanken mobiele en slot  
 Armario con puerta de vidrio CT con 3 anaqueles móviles y cerradura



50 x 46 x 197	<b>AM 0520 HO CT</b>			<b>418</b>		61	0.21
---------------	----------------------	--	--	------------	--	----	------

Armadio con telaio e vetro CT con 3 ripiani mobili e 1 fisso 50 x 46 x 197 **AL 0520 HO CT** **740** - **666** - - 64 0.21  
 Cabinet + frame +CT glass with 3 movable shelves and 1 fixed  
 Arm. cadre et vitre CT avec 3 étagères mobiles et 1 fixe  
 CT Schrank m. tür mit 3 beweglichen und 1 festen Einlegboden  
 Kast met frame en CT glas met 3 mobiele en 1 vast vlak  
 Armario con bastidor y vidrio CT con 3 anaqueles móviles y 1 fijo

**Armadi H. 197**  
**Cabinets**  
**Armoires**  
**Schränke**  
**Kasten**  
**Armarios**

Dimensioni (cm) Dimensions Dimensions Abmessungen Afmetingen Dimensiones <b>L x P x H</b>	Codice Code Code Nummer Code Código	Prezzo - Price - Prix - Preis - Prijs - Precio												Peso Weight Poids Gewicht Peso <b>Kg</b>	Volume Volume Volume Volumen Volume <b>m³</b>	
		Finiture - Finishes - Finitions Ausführungen - Afwerkingen - Acabados														
		CL	PT	L	RS			NT			RN	WE	GP			

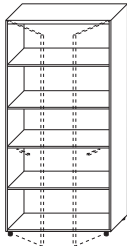

100 x 44 x 197	<b>AM 1020 00 AL</b>													<b>259</b>	76	0.19
100 x 44 x 197	<b>AL 1020 00</b>	<b>740</b>							<b>635</b>					83	0.19	

Armadio **predisposto per anta intera** con 3 ripiani mobili e 1 fisso  
 Cabinet **arranged for entire door** with 3 movable shelves and 1 fixed  
 Armoire **disposé pour porte entière** avec 3 étagères mobiles et 1 fixe  
 Schrank **für ganze tür vorbereitet** mit 3 beweglichen und 1 festen Einlegeboden  
 Kast **lever baar met hele deur** met 3 mobiele en 1 vast vlak  
 Armario **preparado para puerta interna** con 3 anaqueles móviles y 1 fijo

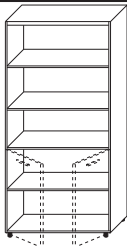

100 x 44 x 197	<b>AM 1020 PI AL</b>													<b>259</b>	76	0.19
100 x 44 x 197	<b>AL 1020 PI</b>	<b>740</b>							<b>635</b>					83	0.19	

Armadio **predisposto per anta bassa** con 3 ripiani mobili e 1 fisso  
 Cabinet **arranged for short door** with 3 movable shelves and 1 fixed  
 Armoire **disposé pour porte basse** avec 3 étagères mobiles et 1 fixe  
 Schrank **für niedrige tür vorbereitet** mit 3 beweglichen und 1 festen Einlegeboden  
 Kast **lever baar met lage deur** met 3 mobiele en 1 vast vlak  
 Armario **preparado para puerta baja** con 3 anaqueles móviles y 1 fijo

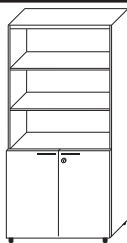

100 x 46 x 197	<b>AM 1020 AO</b>	<b>489</b>				<b>489</b>			<b>456</b>			<b>330</b>		86	0.24
100 x 46 x 197	<b>AL 1020 AO</b>	<b>970</b>							<b>832</b>					93	0.24

Armadio con 3 ripiani e serratura  
 Cabinet with 3 shelves and lock  
 Armoire avec 3 etageres et serrure  
 Schrank mit 3 ablagefächern und schloss  
 Kast met 3 legplanken en slot  
 Armario con 3 estantes y cerradura

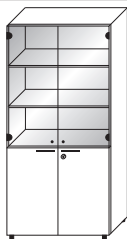

100 x 46 x 197	<b>AM 1020 BO</b>	<b>641</b>				<b>641</b>			<b>608</b>			<b>482</b>		102	0.28
100 x 46 x 197	<b>AL 1020 BO</b>	<b>1.122</b>							<b>984</b>					109	0.28

Armadio con anta in vetro VG con 3 ripiani e 1 serratura  
 Cabinet with VG glass door with 3 shelves and 1 lock  
 Armoire porte vitree VG avec 3 etageres et 1 serrure  
 Schrank mit VG glastür mit 3 ablagefächern und 1 schloss  
 Kast met VG glazen deur met 3 legplanken en 1 slot  
 Armario con puerta de vidrio VG con 3 estantes y 1 cerradura

**Armadi H. 197**  
**Cabinets**  
**Armoires**  
**Schränke**  
**Kasten**  
**Armarios**

Dimensioni (cm) Dimensions Dimensions Abmessungen Afmetingen Dimensiones <b>L x P x H</b>	Codice Code Code Nummer Code Código	Prezzo - Price - Prix - Preis - Prijs - Precio												Peso Weight Poids Gewicht Peso <b>Kg</b>	Volume Volume Volume Volumen Volume Volumen <b>m³</b>
		Finiture - Finishes - Finitions Ausführungen - Afwerkingen - Acabados													
		CL	PT	L	RS			NT			RN	WE	GP		

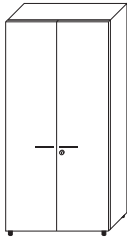

100 x 46 x 197	<b>AM 1020 CO</b>	<b>735</b>	<b>735</b>	<b>661</b>	<b>423</b>	101	0.3
----------------	-------------------	------------	------------	------------	------------	-----	-----

Armadio con 3 ripiani mobili e 1 fisso, 1 serratura

Cabinet with 3 movable shelves and 1 fixed, 1 lock

Armoire avec 3 étagères mobiles et 1 fixe, 1 serrure

Schrank mit 3 beweglichen und 1 festen Einlegboden, 1 schloss

Kast met 3 mobiele en 1 vast vlak, 1 slot

Armario con 3 anaqueles móviles y 1 fijo, 1 cerradura

100 x 46 x 197	<b>AL 1020 CO</b>	<b>1.216</b>	-	<b>1.037</b>	-	108	0.3
----------------	-------------------	--------------	---	--------------	---	-----	-----

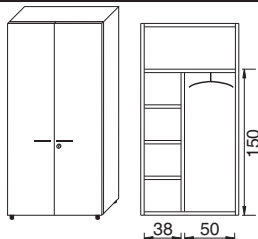

100 x 46 x 197	<b>AM 1020 EO</b>	<b>800</b>	<b>800</b>	<b>726</b>	<b>488</b>	98	0.29
----------------	-------------------	------------	------------	------------	------------	----	------

Armadio appendiabiti con 1 ripiano, riloga e serratura

Clothes-hanger cabinet with 1 shelf, rail and lock

Penderie avec 1 etagere, tringle et serrure

Garderobeschrank mit 1 ablagefach und schloss

Hangkast met 1 legplank en slot

Armario con perchero, 1 estante y cerradura

100 x 46 x 197	<b>AL 1020 EO</b>	<b>1.258</b>	-	<b>1.073</b>	-	101	0.29
----------------	-------------------	--------------	---	--------------	---	-----	------

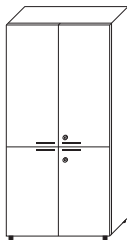

Non disponibile in CL - PT  
 Not available in CL - PT  
 No disponible en CL - PT  
 Nicht vorhanden im CL - PT  
 Niet beschikbaar in CL - PT

100 x 46 x 197	<b>AM 1020 FO</b>	<b>793</b>	-	-	<b>437</b>	101	0.31
----------------	-------------------	------------	---	---	------------	-----	------

Armadio con 3 ripiani e 2 serrature

Cabinet with 3 shelves and 2 locks

Armoire avec 3 etageres et 2 serrures

Schrank mit 3 Ablagefächern und 2 schloss

Kast met 3 legplanken en 2 slot

Armario con 3 estantes y 2 cerraduras

100 x 46 x 197	<b>AL 1020 FO</b>	<b>1.274</b>	-	-	<b>918</b>	108	0.31
----------------	-------------------	--------------	---	---	------------	-----	------

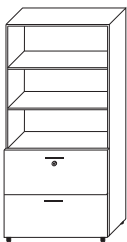

Non disponibile in CL - PT  
 Not available in CL - PT  
 No disponible en CL - PT  
 Nicht vorhanden im CL - PT  
 Niet beschikbaar in CL - PT

100 x 46 x 197	<b>AM 1020 GO</b>	<b>646</b>	-	-	<b>538</b>	92	0.31
----------------	-------------------	------------	---	---	------------	----	------

Armadio con 2 ripiani e 1 serratura (cartelle 2 x cm. 33 oppure 2 x cm. 39)

Cabinet with 2 shelves and 1 lock (files: 2 x 33 cm or 2 x 39 cm)

Armoire avec 2 etageres et 1 serrure (dossiers 2 x 33 cm ou 2 x 39 cm)

Schrank mit 2 Ablagefächern und 1 schloss (register 2 x 33 cm oder 2 x 39 cm)

Kast met 2 legplanken en 1 slot (mappen 2 x 33 cm of 2 x 39 cm)

Armario con 2 estantes y 1 cerradura (carpetas 2 x cm. 33 o bien 2 x cm. 39)

100 x 46 x 197	<b>AL 1020 GO</b>	<b>1.090</b>	-	-	<b>982</b>	99	0.31
----------------	-------------------	--------------	---	---	------------	----	------

## Armadi H. 197

Cabinets  
Armoires  
Schränke  
Kasten  
Armarios

Dimensioni (cm) Dimensions Dimensions Abmessungen Afmetingen Dimensiones <b>L x P x H</b>	Codice Code Code Nummer Code Código	Prezzo - Price - Prix - Preis - Prijs - Precio									Peso Weight Poids Gewicht Peso <b>Kg</b>	Volume Volume Volume Volumen Volume Volumen <b>m³</b>
		Finiture - Finishes - Finitions Ausführungen - Afwerkingen - Acabados										
		CL	PT	L	RS			NT				

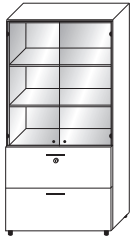

Non disponibile in CL - PT  
Not available in CL - PT  
No disponible en CL - PT  
Nicht vorhanden im CL - PT  
Niet beschikbaar in CL - PT

100 x 46 x 197	<b>AM 1020 HO</b>	<b>798</b>	-	-	<b>690</b>	108	0.35
100 x 46 x 197	<b>AL 1020 HO</b>	<b>1.242</b>	-	-	<b>1.134</b>	115	0.35

Armadio con ante in vetro VG con 2 ripiani mobili e 1 fisso, 1 serratura (cartelle 2 x cm. 33 oppure 2 x cm. 39)

Cabinet with VG glass doors with 2 movable shelves and 1 fixed, 1 lock (files: 2 x 33 cm or 2 x 39 cm)

Armoire portes vitrees VG avec 2 étagères mobiles et 1 fixe, 1 serrure (dossiers 2 x 33 cm ou 2 x 39 cm)

Schrank mit VG glastür mit 2 beweglichen und 1 festen Einlegboden, 1 schloss (register 2 x 33 cm oder 2 x 39 cm)

Kast met VG glazen deuren met 2 mobiele en 1 vast vlak, 1 slot (mappen 2 x 33 cm of 2 x 39 cm)

Armario con puertas de vidrio vg con 2 anaqueles móviles y 1 fijo, 1 cerraduras (carpetas 2 x cm. 33 o bien 2 x cm. 39)

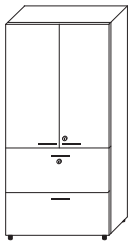

Non disponibile in CL - PT  
Not available in CL - PT  
No disponible en CL - PT  
Nicht vorhanden im CL - PT  
Niet beschikbaar in CL - PT

100 x 46 x 197	<b>AM 1020 LO</b>	<b>950</b>	-	-	<b>645</b>	107	0.38
100 x 46 x 197	<b>AL 1020 LO</b>	<b>1.394</b>	-	-	<b>1.089</b>	114	0.38

Armadio con 2 ripiani mobili e 1 fisso, 1 serratura (cartelle 2 x cm. 33 oppure 2 x cm. 39)

Cabinet with 2 movable shelves and 1 fixed, 1 lock (files: 2 x 33 cm or 2 x 39 cm)

Armoire avec 2 étagères mobiles et 1 fixe, 1 serrure (dossiers 2 x 33 cm ou 2 x 39 cm)

Schrank mit 2 beweglichen und 1 festen Einlegboden, 1 schloss (register 2 x 33 cm oder 2 x 39 cm)

Kast met 2 mobiele en 1 vast vlak, 1 slot (mappen 2 x 33 cm of 2 x 39 cm)

Armario con 2 anaqueles móviles y 1 fijo, 1 cerradura (carpetas 2 x cm. 33 o bien 2 x cm. 39)

**Armadi H. 197**  
**Cabinets**  
**Armoires**  
**Schränke**  
**Kasten**  
**Armarios**

Dimensioni (cm) Dimensions Dimensions Abmessungen Afmetingen Dimensiones <b>L x P x H</b>	Codice Code Code Nummer Code Código	Prezzo - Price - Prix - Preis - Prijs - Precio												Peso Weight Poids Gewicht Peso <b>Kg</b>	Volume Volume Volume Volumen Volume Volumen <b>m³</b>
		Finiture - Finishes - Finitions Ausführungen - Afwerkingen - Acabados													
		CL	PT	L	RS			NT			RN	WE	GP		



100 x 46 x 197	<b>AM 1020 MO</b>	<b>810</b>	<b>810</b>	<b>777</b>	<b>651</b>	101	0.3
100 x 46 x 197	<b>AL 1020 MO</b>	<b>1.291</b>	-	<b>1.153</b>	-	108	0.3

Armadio con telai e vetro CT con 3 ripiani e 1 serratura  
 Cabinet+ frame +CT glass with 3 shelves and 1 lock  
 Armoire cadre et vitre CT avec 3 étagères et 1 serrure  
 CT schrank m. tür mit 3 Ablagefächern und 1 Schloss  
 Kast met frames en CT glas met 3 legplanken en 1 slot  
 Armario con bastidores y vidrio CT con 3 estantes y 1 cerradura

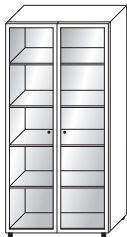

100 x 46 x 197	<b>AM 1020 NO CT</b>			<b>702</b>		99	0.29
100 x 46 x 197	<b>AL 1020 NO CT</b>	<b>1.183</b>	-	<b>1.139</b>	-	107	0.29

Armadio con telai e vetro CT con 4 ripiani  
 Cabinet+ frame +CT glass with 4 shelves  
 Armoire cadre et vitre CT avec 4 étagères  
 CT schrank m. tür mit 4 Ablagefächern  
 Kast met frames en CT glas met 4 legplanken  
 Armario con bastidores y vidrio CT con 4 estantes



Non disponibile in CL - PT  
 Not available in CL - PT  
 No disponible en CL - PT  
 Nicht vorhanden im CL - PT  
 Niet beschikbaar in CL - PT

100 x 46 x 197	<b>AM 1020 PO</b>	<b>967</b>	-	-	<b>859</b>	107	0.37
100 x 46 x 197	<b>AL 1020 PO</b>	<b>1.411</b>	-	-	<b>1.303</b>	114	0.37

Armadio con ante in vetro CT con 2 ripiani e serratura (cartelle 2 x cm. 33 oppure 2 x cm. 39)  
 Cabinet with CT glass doors with 2 shelves and lock (files: 2 x 33 cm or 2 x 39 cm)  
 Armoire portes vitrees CT avec 2 etageres et serrure (dossiers 2 x 33 cm ou 2 x 39 cm)  
 Schrank mit CT glastür mit 2 Ablagefächern und schloss (register 2 x 33 cm oder 2 x 39 cm)  
 Kast met CT glazen deuren met 2 legplanken en slot (mappen 2 x 33 cm of 2 x 39 cm)  
 Armario con puertas de vidrio CT con 2 anaqueles y cerradura (carpeta 2 x cm. 33 o bien 2 x cm. 39)

**Armadi**  
**Cabinets**  
**Armoires**  
**Schränke**  
**Kasten**  
**Armarios**

Dimensioni (cm) Dimensions Dimensions Abmessungen Afmetingen Dimensiones <b>L x P x H</b>	Codice Code Code Nummer Code Código	Prezzo - Price - Prix - Preis - Prijs - Precio										Peso Weight Poids Gewicht Peso <b>Kg</b>	Volume Volume Volume Volume Volume Peso <b>m³</b>
		Finiture - Finishes - Finitions Ausführungen - Afwerkingen - Acabados											
		CL	PT	L	RS			NT			RN		

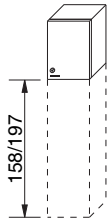

50 x 46 x 76.8	<b>AM 0508 SD</b>	<b>222</b>	<b>222</b>	<b>204</b>	<b>133</b>	26	0.07
----------------	-------------------	------------	------------	------------	------------	----	------

Armadio per sopralzo con 1 ripiano e serratura  
Cabinet for upper element with 1 shelf and lock  
Armoire pour element superieur avec 1 étagère et serrure  
Schränke für erhöhung mit 1 Ablagefach und Schloss  
Kasten voor opbouw met 1 legplank en slot  
Armario para sotabanco con 1 estante y cerradura

50 x 46 x 76.8	<b>AL 0508 SD</b>	<b>374</b>	<b>-</b>	<b>356</b>	<b>285</b>	28	0.07
----------------	-------------------	------------	----------	------------	------------	----	------

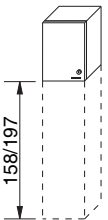

50 x 46 x 76.8	<b>AM 0508 SS</b>	<b>222</b>	<b>222</b>	<b>204</b>	<b>133</b>	26	0.07
----------------	-------------------	------------	------------	------------	------------	----	------

Armadio per sopralzo con 1 ripiano e serratura  
Cabinet for upper element with 1 shelf and lock  
Armoire pour element superieur avec 1 étagère et serrure  
Schränke für erhöhung mit 1 Ablagefach und Schloss  
Kasten voor opbouw met 1 legplank en slot  
Armario para sotabanco con 1 estante y cerradura

50 x 46 x 76.8	<b>AL 0508 SS</b>	<b>374</b>	<b>-</b>	<b>356</b>	<b>285</b>	28	0.07
----------------	-------------------	------------	----------	------------	------------	----	------

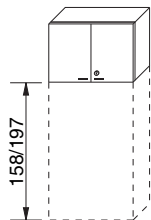

100 x 46 x 76.8	<b>AM 1008 SO</b>	<b>345</b>	<b>345</b>	<b>312</b>	<b>186</b>	42	0.14
-----------------	-------------------	------------	------------	------------	------------	----	------

Armadio per sopralzo con 1 ripiano e serratura  
Cabinet for upper element with 1 shelf and lock  
Armoire pour element superieur avec 1 étagère et serrure  
Schränke für erhöhung mit 1 Ablagefach und Schloss  
Kasten voor opbouw met 1 legplank en slot  
Armario para sotabanco con 1 estante y cerradura

100 x 46 x 76.8	<b>AL 1008 SO</b>	<b>569</b>	<b>-</b>	<b>536</b>	<b>410</b>	46	0.14
-----------------	-------------------	------------	----------	------------	------------	----	------



**Complementi per armadi**  
**Complementary accessories for cabinets**  
**Complements pour armoires**  
**Schrankzubehörteile**  
**Kastaccessoires**  
**Complementos para armarios**

Dimensioni (cm) Dimensions Dimensions Abmessungen Afmetingen Dimensiones <b>L x P x H</b>	Codice Code Code Nummer Code Código	Prezzo - Price - Prix - Preis - Prijs - Precio										Peso Weight Poids Gewicht Peso <b>Kg</b>	Volume Volume Volume Volumen Volume Volumen <b>m³</b>
		Finiture - Finishes - Finitions Ausführungen - Afwerkingen - Acabados											
		CL	PT	RS	NT			L					
		AM											

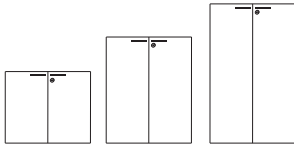

Coppia ante (Con serratura)

Pair door (With lock)

Paire portes (Avec serrure)

Paar türen (Mit schloss)

Set deurtjes (Slot)

Par de puertas (con cerradura)

100 x 1.9 x 76.4	<b>AN 1008 S1</b>	<b>230</b>	<b>197</b>	<b>230</b>	10	0.05
100 x 1.9 x 114.7	<b>AN 1012 S1</b>	-	-	<b>304</b>	15	0.07
100 x 1.9 x 153.2	<b>AN 1016 S1</b>	<b>379</b>	<b>317</b>	<b>379</b>	20	0.09

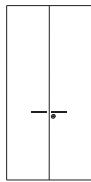

Coppia ante (Con serratura ad aste rotanti)

Pair door (With lock rotating spindles)

Paire portes (Avec serrure tiges pivotantes)

Paar türen (Mit schloss drehstangen)

Set deurtjes (Slot draaiende stangen)

Par de puertas (con cerradura y barras que dan vuelta)

100 x 1.9 x 191.6	<b>AN 1020 S1</b>	<b>476</b>	<b>402</b>	<b>476</b>	25	0.11
-------------------	-------------------	------------	------------	------------	----	------



Anta per sopralzo (Con serratura)

Door for upper element (With lock)

Porte pour element superieur (Avec serrure)

Tür für aufsatzschrank (Mit schloss)

Deur voor opzetstuk (Slot)

Puerta para sobabanco (con cerradura)

50 x 1.8 x 76.4	<b>AN 0508 DP</b>	<b>132</b>	<b>114</b>	<b>132</b>	5	0.02
-----------------	-------------------	------------	------------	------------	---	------



Anta per sopralzo (Con serratura)

Door for upper element (With lock)

Porte pour element superieur (Avec serrure)

Tür für aufsatzschrank (Mit schloss)

Deur voor opzetstuk (Slot)

Puerta para sobabanco (con cerradura)

50 x 1.8 x 76.4	<b>AN 0508 SP</b>	<b>132</b>	<b>114</b>	<b>132</b>	5	0.02
-----------------	-------------------	------------	------------	------------	---	------

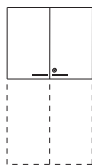

Coppia ante per sopralzo (Con serratura)

Pair doors for upper element (With lock)

Paire porte pour element superieur (Avec serrure)

Türen paar für aufsatzschrank (Mit schloss)

1 paar deuren voor opzetstuk (Slot)

Par de puertas para sobabanco (con cerradura)

100 x 1.8 x 76.4	<b>AN 1008 SP</b>	<b>230</b>	<b>197</b>	<b>230</b>	10	0.05
------------------	-------------------	------------	------------	------------	----	------

**Complementi per armadi**  
**Complementary accessories for cabinets**  
**Complements pour armoires**  
**Schrankzubehörteile**  
**Kastaccessoires**  
**Complementos para armarios**

Dimensioni (cm) Dimensions Dimensions Abmessungen Afmetingen Dimensiones <b>L x P x H</b>	Codice Code Code Nummer Code Código	Prezzo - Price - Prix - Preis - Prijs - Precio												Peso Weight Poids Gewicht Peso <b>Kg</b>	Volume Volume Volume Volumen Volume Volumen <b>m³</b>
		Finiture - Finishes - Finitions Ausführungen - Afwerkingen - Acabados													
		RN	WE	GP											
AC	BL														

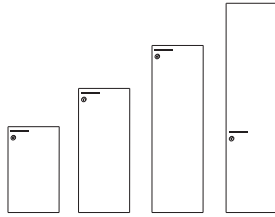

Anta Dx (con serratura)  
 Right door (with lock)  
 Porte droite (avec serrure)  
 Tür rechts (mit schloss)  
 Deur rechts (slot)  
 Puerta derecha (con cerradura)

50 x 1.8 x 76.4	<b>AN 0508 DX</b>												<b>43</b>	5	0.02
50 x 1.8 x 114.7	<b>AN 0512 DX</b>												<b>53</b>	8	0.03
50 x 1.8 x 153.2	<b>AN 0516 DX</b>												<b>65</b>	10	0.04
50 x 1.8 x 191.6	<b>AN 0520 DX</b>												<b>77</b>	13	0.05

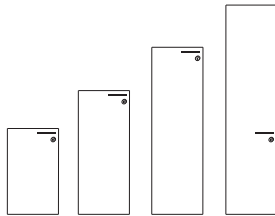

Anta Sx (con serratura)  
 Left door (with lock)  
 Porte gauche (avec serrure)  
 Tür links (mit schloss)  
 Deur links (slot)  
 Puerta izquierta (con cerradura)

50 x 1.8 x 76.4	<b>AN 0508 SX</b>												<b>43</b>	5	0.02
50 x 1.8 x 114.7	<b>AN 0512 SX</b>												<b>53</b>	8	0.03
50 x 1.8 x 153.2	<b>AN 0516 SX</b>												<b>65</b>	10	0.04
50 x 1.8 x 191.6	<b>AN 0520 SX</b>												<b>77</b>	13	0.05



Anta Dx (**per armadio appendiabiti**) con serratura  
 Right door (**for clothes-hanger cabinet**) with lock  
 Porte droite (**pour penderie**) avec serrure  
 Tür rechts (**garde robeschrank**) mit schloss  
 Deur rechts (**hangkast**) slot  
 Puerta derecha (**para armario con perchero**) con cerradura

50 x 1.8 x 191.6	<b>AN 0519 AD</b>												<b>77</b>	13	0.05
------------------	-------------------	--	--	--	--	--	--	--	--	--	--	--	-----------	----	------



Anta Sx (**per armadio appendiabiti**) con serratura  
 Left door (**for clothes-hanger cabinet**) with lock  
 Porte gauche (**pour penderie**) avec serrure  
 Tür Li (**garde robeschrank**) mit schloss  
 Deur links (**hangkast**) slot  
 Puerta izquierta (**para armario con perchero**) con cerradura

50 x 1.8 x 191.6	<b>AN 0519 AS</b>												<b>77</b>	13	0.05
------------------	-------------------	--	--	--	--	--	--	--	--	--	--	--	-----------	----	------

**Complementi per armadi**  
**Complementary accessories for cabinets**  
**Complements pour armoires**  
**Schrankzubehörteile**  
**Kastaccessoires**  
**Complementos para armarios**

Dimensioni (cm) Dimensions Dimensions Abmessungen Afmetingen Dimensiones <b>L x P x H</b>	Codice Code Code Nummer Code Código	Prezzo - Price - Prix - Preis - Prijs - Precio										Peso Weight Poids Gewicht Peso <b>Kg</b>	Volume Volume Volume Volumen Volume <b>m³</b>
		Finiture - Finishes - Finitions Ausführungen - Afwerkingen - Acabados											
		RN	WE	GP									
AC	BL												

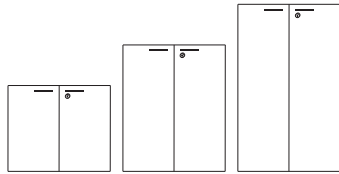

100 x 1.8 x 76.4	<b>AN 1008 S1</b>	<b>71</b>	10	0.05
10 x 1.8 x 114.7	<b>AN 1012 S1</b>	<b>107</b>	15	0.07
10 x 1.8 x 153.2	<b>AN 1016 S1</b>	<b>140</b>	20	0.09

Coppia ante (Con serratura)  
 Pair door (With lock)  
 Paire portes (Avec serrure)  
 Paar türen (Mit schloss)  
 Set deurtjes (Slot)  
 Par de puertas (con cerradura)

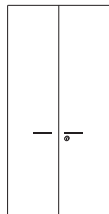

100 x 1.8 x 191.6	<b>AN 1020 S1</b>	<b>164</b>	25	0.11
-------------------	-------------------	------------	----	------

Coppia ante (Con serratura ad aste rotanti)  
 Pair door (With lock rotating spindles)  
 Paire portes (Avec serrure tiges pivotantes)  
 Paar türen (Mit schloss drehstangen)  
 Set deurtjes (Slot draaiende stangen)  
 Par de puertas (con cerradura y barras que dan vuelta)

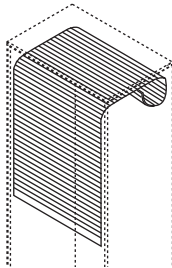

	<b>AZ 1016 SE AP</b>	<b>325</b>	8	0.01
--	----------------------	------------	---	------

Kit tapparella per AM 1016 00 AL con serratura  
 Roll up door kit for AM 1016 00 AL with lock  
 Kit rideau pour AM 1016 00 AL avec serrure  
 Bausatz Rollltür für AM 1016 00 AL mit Schloss  
 Kit rolluik voor AM 1016 00 AL met slot  
 Kit persiana enrollable para AM 1016 AL con cerradura

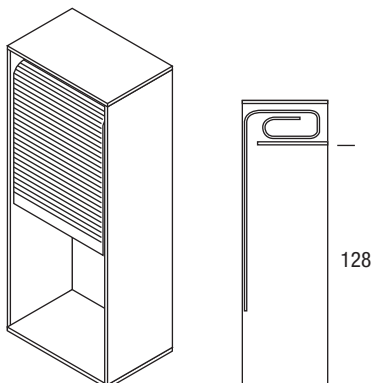

**Complementi per armadi**  
**Complementary accessories for cabinets**  
**Complements pour armoires**  
**Schrankzubehörteile**  
**Kastaccessoires**  
**Complementos para armarios**

Dimensioni (cm) Dimensions Dimensions Abmessungen Afmetingen Dimensiones <b>L x P x H</b>	Codice Code Code Nummer Code Código	Prezzo - Price - Prix - Preis - Prijs - Precio										Peso Weight Poids Gewicht Peso <b>Kg</b>	Volume Volume Volume Volumen Volume Volumen <b>m³</b>
		Finiture - Finishes - Finitions											
		Ausführungen - Afwerkingen - Acabados											
		RN	WE	GP	L								
		AC	BL										

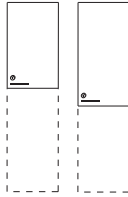

50 x 1.8 x 76.4	<b>AN 0508 DP</b>	<b>43</b>	<b>132</b>	-	5	0.02
-----------------	-------------------	-----------	------------	---	---	------

50 x 1.8 x 114.8	<b>AN 0512 DP</b>	<b>53</b>	<b>169</b>	-	8	0.03
------------------	-------------------	-----------	------------	---	---	------

Anta per sopralzo (Con serratura)  
 Door for upper element (With lock)  
 Porte pour element superieur (Avec serrure)  
 Tür für aufsatzschrank (Mit schloss)  
 Deur voor opzetstuk (Slot)  
 Puerta para sotabanco (con cerradura)

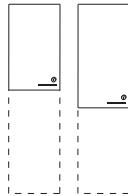

50 x 1.8 x 76.4	<b>AN 0508 SP</b>	<b>43</b>	<b>132</b>	-	5	0.02
-----------------	-------------------	-----------	------------	---	---	------

50 x 1.8 x 114.8	<b>AN 0512 SP</b>	<b>53</b>	<b>169</b>	-	8	0.03
------------------	-------------------	-----------	------------	---	---	------

Anta per sopralzo (Con serratura)  
 Door for upper element (With lock)  
 Porte pour element superieur (Avec serrure)  
 Tür für aufsatzschrank (Mit schloss)  
 Deur voor opzetstuk (Slot)  
 Puerta para sotabanco (con cerradura)

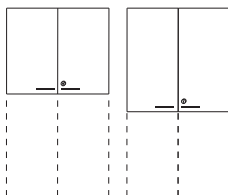

100 x 1.8 x 76.4	<b>AN 1008 SP</b>	<b>71</b>	<b>230</b>	-	10	0.05
------------------	-------------------	-----------	------------	---	----	------

100 x 1.8 x 114.8	<b>AN 1012 SP</b>	<b>107</b>	<b>304</b>	-	15	0.07
-------------------	-------------------	------------	------------	---	----	------

Coppia ante per sopralzo (Con serratura)  
 Pair doors for upper element (With lock)  
 Paire porte pour element superieur (Avec serrure)  
 Türen paar für aufsatzschrank (Mit schloss)  
 1 paar deuren voor opzetstuk (Slot)  
 Par de puertas para sotabanco (con cerradura)

**Complementi per armadi**  
**Complementary accessories for cabinets**  
**Complements pour armoires**  
**Schrankzubehörteile**  
**Kastaccessoires**  
**Complementos para armarios**

Dimensioni (cm) Dimensions Dimensions Abmessungen Afmetingen Dimensiones <b>L x P x H</b>	Codice Code Code Nummer Code Código	Prezzo - Price - Prix - Preis - Prijs - Precio						Peso Weight Poids Gewicht Peso <b>Kg</b>	Volume Volume Volume Volumen Volume Volume <b>m³</b>
		Finiture - Finishes - Finitions Ausführungen - Afwerkingen - Acabados							
		RN	WE	GP	L		AF		
		AC	BL						

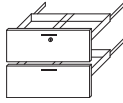

Gruppo 2 estraibili con serratura (cartelle 2 x cm. 33 oppure 2 x cm. 39)

100 x 1.8 x 76.4 **ES 1008 S1** **300** **408** **-** 23 0.14

Group 2 extractables with lock (files: 2 x 33 cm or 2 x 39 cm)

Groupe 2 extractibles avec serrure (dossiers 2 x 33 cm ou 2 x 39 cm)

2 Ausziehbare garnitur mit schloss (register 2 x 33 cm oder 2 x 39 cm)

Stel 2 uittrekbare elementen met sluiting (mappen 2 x 33 cm of 2 x 39 cm)

Grupo de 2 extraibles con cerradura (carpeta 2 x cm. 33 o bien 2 x cm. 39)



Gruppo 3 estraibili con serratura (cartelle 3 x cm. 33 oppure 2 x cm. 39)

100 x 1.8 x 118 **ES 1012 S3** **462** **590** **-** 34 0.19

Group 3 extractables with lock (files: 3 x 33 cm or 2 x 39 cm)

Groupe 3 extractibles avec serrure (dossiers 3 x 33 cm ou 2 x 39 cm)

3 Ausziehbare garnitur mit schloss (register 3 x 33 cm oder 2 x 39 cm)

Stel 3 uittrekbare elementen met sluiting (mappen 3 x 33 cm of 2 x 39 cm)

Grupo 3 extraibles con cerradura (carpetas 3 x cm. 33 o bien 2 x cm. 39)

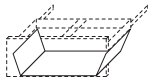

Fondo per estraibile ES 1008 S1 ed ES 1012 S3

89 x 39 x 18 **ES 1008 F1 AF** **-** **-** **99** 6 0.09

Bottom for pull-out frame ES 1008 S1 and ES 1012 S3

Fond pour fond extractible ES 1008 S1 et ES 1012 S3

Boden für Schrankauszug ES 1008 S1 und ES 1012 S3

Bodem voor uitneembare ES 1008 S1 en ES 1012 S3

Fondo para extraible ES 1008 S1 y ES 1012 S3

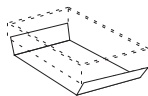

Fondo per estraibile AZ 0904 00 AF

86 x 33 x 18 **AZ 0904 F1 AF** **-** **-** **91** 5 0.03

Bottom for pull-out frame AZ 0904 00 AF

Fond pour fond extractible AZ 0904 00 AF

Boden für Schrankauszug AZ 0904 00 AF

Bodem voor uitneembare AZ 0904 00 AF

Fondo para extraible AZ 0904 00 AF

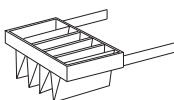

Telaio portacartelle estraibile (cartelle 2x33 oppure 2x38)

96.2 x 35.5 x 9 **AZ 0904 00 AF** **-** **-** **136** 5 0.04

Pull-out fil.frame sus.files (susp. file 2x33 or 2x36)

Cadre dossiers susp. extrac.

Rahmen auszieh-hangeregister

Uittrekbaar hangmappenframe

Bastidor contenidor carpetas extraible (carpetas 2x33 o bien 2x38)

**Complementi per armadi**  
**Complementary accessories for cabinets**  
**Complements pour armoires**  
**Schrankzubehörteile**  
**Kastaccessoires**  
**Complementos para armarios**

Dimensioni (cm) Dimensions Dimensions Abmessungen Afmetingen Dimensiones <b>L x P x H</b>	Codice Code Code Nummer Code Código	Prezzo - Price - Prix - Preis - Prijs - Precio						Peso Weight Poids Gewicht Peso <b>Kg</b>	Volume Volume Volume Volumen Volume Volumen <b>m<sup>3</sup></b>
		Finiture - Finishes - Finitions Ausführungen - Afwerkingen - Acabados							
		CT			C-				

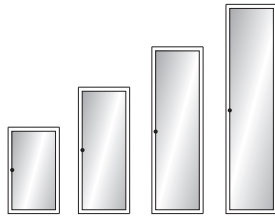

Anta Dx/Sx con telaio e vetro (Senza serratura)  
 Door rh/lh with frame and glass (with out lock)  
 Porte d/g avec chassis et verre opaque (sans serrure)  
 Türen mit rahmen und einsatz aus glas (ohne schloss)  
 Frame en glas dikte deurtjes (zonder slot)  
 Puerta derecha/izquierda con bastidor y vidrio (sin cerradura)

50 x 2 x 76.4	<b>VA 0508 01</b>	<b>138</b>	<b>173</b>	-			6	0.04
50 x 2 x 114.8	<b>VA 0512 01</b>	<b>168</b>	<b>209</b>	-			8	0.06
50 x 2 x 153.2	<b>VA 0516 01</b>	<b>201</b>	<b>251</b>	-			11	0.08
50 x 2 x 191.6	<b>VA 0520 01</b>	<b>231</b>	<b>287</b>	-			13	0.1

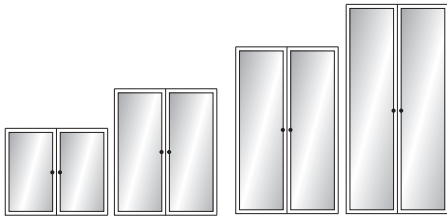

Coppia ante con telaio e vetro acidato (Senza serratura)  
 Pair doors with frame and opaque glass (with out lock)  
 Paire portes avec chassis et verre opaque (sans serrure)  
 Türenpaar mit rahmen und einsatz aus geätztem glas (ohne schloss)  
 1 paar deuren met frame en matglas dikte (zonder slot)  
 Par de puertas con bastidor y vidrio opaco (sin cerradura)

100 x 2 x 76.4	<b>VA 1008 00</b>	<b>265</b>	<b>325</b>	-			10	0.04
100 x 2 x 114.8	<b>VA 1012 00</b>	<b>321</b>	<b>394</b>	-			15	0.06
100 x 2 x 153.2	<b>VA 1016 00</b>	<b>384</b>	<b>472</b>	-			19	0.08
100 x 2 x 191.6	<b>VA 1020 00</b>	<b>443</b>	<b>545</b>	-			23	0.1

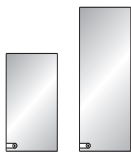

Anta Dx/Sx in vetro VG (Con serratura)  
 Door rh/lh in VG glass (With lock)  
 Porte d/g en verre VG (Avec serrure)  
 Türen mit einsatz aus VG glas re/li (Mit schloss)  
 VG glazen deurtjes re/li (Slot)  
 Puerta derecha/izquierda de vidrio VG (con cerradura)

50 x 0.5 x 76.4	<b>VG 0508 S1</b>	-	-	<b>71</b>			8	0.04
50 x 0.5 x 114.8	<b>VG 0512 S1</b>	-	-	<b>84</b>			8	0.04

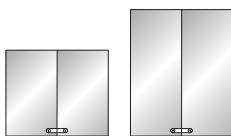

Coppia ante in vetro VG (Con serratura)  
 Pair door in VG glass (With lock)  
 Paire portes en verre VG (Avec serrure)  
 Türen paar aus VG glas (Mit schloss)  
 1 paar deuren VG glazen (Slot)  
 Par de puertas de vidrio VG (con cerradura)

100 x 0.5 x 76.4	<b>VG 1008 S1</b>	-	-	<b>129</b>			10	0.03
100 x 0.5 x 114.8	<b>VG 1012 S1</b>	-	-	<b>152</b>			16	0.04

**Complementi per armadi**  
**Complementary accessories for cabinets**  
**Complements pour armoires**  
**Schrankszubehörteile**  
**Kastaccessoires**  
**Complementos para armarios**

Dimensioni (cm) Dimensions Dimensions Abmessungen Afmetingen Dimensiones <b>L x P x H</b>	Codice Code Code Nummer Code Código	Prezzo - Price - Prix - Preis - Prijs - Precio												Peso Weight Poids Gewicht Peso <b>Kg</b>	Volume Volume Volume Volume Volume Volume <b>m³</b>
		Finiture - Finishes - Finitions Ausführungen - Afwerkingen - Acabados													
		CL	PT	RS	NT			L			RN	WE	GP		

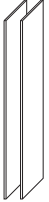
	1.8 x 46 x 82.8	<b>FL 0008 02</b>	<b>159</b>	<b>138</b>	<b>159</b>	<b>54</b>	10	0.03
Coppia fianchi di chiusura (in melaminico) aggiungere gli zoccoli in alluminio	1.8 x 46 x 121.3	<b>FL 0012 02</b>	-	-	<b>200</b>	<b>73</b>	15	0.04
Pair of closing sides (in melamine) add the aluminium plinthes	1.8 x 46 x 159.6	<b>FL 0016 02</b>	<b>275</b>	<b>237</b>	<b>275</b>	<b>94</b>	19	0.05
Paire flancs de finition (en melamine) ajouter plinthes en aluminium	1.8 x 46 x 198.1	<b>FL 0020 02</b>	<b>338</b>	<b>290</b>	<b>338</b>	<b>114</b>	24	0.06
Paar abschlussflanken (mit melamin) die sockel aus aluminium	1.8 x 46 x 236.5	<b>FL 0024 02</b>	<b>370</b>	<b>401</b>	<b>370</b>	<b>135</b>	27	0.07
Paar zijpanelen (van melamine) plinthen in aluminium toevoegen	1.8 x 46 x 274.9	<b>FL 0028 02</b>	<b>414</b>	<b>463</b>	<b>414</b>	<b>156</b>	33	0.08
Par de costados de cierre (de melamínico) añadir los zócalos de aluminio								

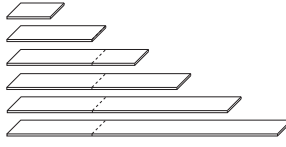
	50 x 46 x 1.8	<b>TP 0505 00</b>	<b>65</b>	<b>59</b>	<b>65</b>	<b>13</b>	3	0.01
Top	100 x 46 x 1.8	<b>TP 1005 00</b>	<b>110</b>	<b>97</b>	<b>110</b>	<b>26</b>	6	0.02
Top	150 x 46 x 1.8	<b>TP 1505 00</b>	<b>149</b>	<b>130</b>	<b>149</b>	<b>39</b>	9	0.03
Top	200 x 46 x 1.8	<b>TP 2005 00</b>	<b>186</b>	<b>161</b>	<b>186</b>	<b>52</b>	12	0.04
Top	250 x 46 x 1.8	<b>TP 2505 00</b>	<b>222</b>	<b>194</b>	<b>222</b>	<b>65</b>	15	0.05
Abdeckplatte	300 x 46 x 1.8	<b>TP 3005 00</b>	<b>260</b>	<b>224</b>	<b>260</b>	<b>78</b>	18	0.06
Topblad								
Parte superior								

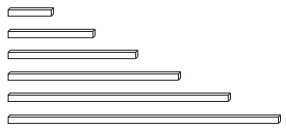
	Dimensioni (cm)	Codice	Prezzo - Price - Prix - Preis - Prijs - Precio												Peso	Volume
			AF													
	50 x 2 x 4	<b>ZL 0500 00 AF</b>	<b>21</b>	-	-	-	1	0.01								
Zoccoli in alluminio Obbligatorii con fianchi di chiusura	100 x 2 x 4	<b>ZL 1000 00 AF</b>	<b>31</b>	-	-	-	1	0.01								
Aluminium plinths Mandatory with closing sides	150 x 2 x 4	<b>ZL 1500 00 AF</b>	<b>42</b>	-	-	-	1	0.02								
Plinthes en aluminium Obligatoires avec flancs de fermeture	200 x 2 x 4	<b>ZL 2000 00 AF</b>	<b>54</b>	-	-	-	1	0.02								
Sockel aus Aluminium Obligatorish mit Abschlussflanken	250 x 2 x 4	<b>ZL 2500 00 AF</b>	<b>64</b>	-	-	-	1	0.02								
Plinten in aluminium Verplichtend bij zijpanelen	300 x 2 x 4	<b>ZL 3000 00 AF</b>	<b>74</b>	-	-	-	1	0.02								
Zócalos de aluminio obligatorios con costados de cierre																

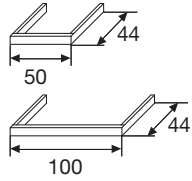
	50 x 44 x 4	<b>ZF 0500 00 AF</b>	<b>35</b>	-	-	-	1	0.01
Zoccolo indipendente in metallo (opzionale senza fianchi di chiusura)	100 x 44 x 4	<b>ZF 1000 00 AF</b>	<b>47</b>	-	-	-	2	0.01
Independent skirting board in metal (optional, without end modules)								
Plinthe indépendante en métal (option dans les côtés de fermeture)								
Getrennte Metallsockelleiste (als Optional ohne abschließende Seitenwände erhältlich)								
Losstaande metalen sokkel (optie zonder zijpanelen)								
Zócalo independiente de metal (opcional sin costados de cierre)								

**Complementi per armadi**  
**Complementary accessories for cabinets**  
**Complements pour armoires**  
**Schrankzubehörteile**  
**Kastaccessoires**  
**Complementos para armarios**

Dimensioni (cm) Dimensions Dimensions Abmessungen Afmetingen Dimensiones <b>L x P x H</b>	Codice Code Code Nummer Code Código	Prezzo - Price - Prix - Preis - Prijs - Precio												Peso Weight Poids Gewicht Peso <b>Kg</b>	Volume Volume Volume Volumen Volume Volumen <b>m³</b>
		Finiture - Finishes - Finitions Ausführungen - Afwerkingen - Acabados													
		CL	PT	L	RS			NT			RN	WE	GP		
											AC	BL			

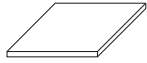

46.2 x 40.8 x 2.5 **RM 0504 01 AL** **14** 3 0.01

Ripiano (portata max. kg. 34)  
 Top (max. cap. 34 kg)  
 Etagere cap. max. 34 kg  
 Ablagefach (max. tragfähigkeit 34 kg)  
 Elegplank (max. draagvermogen 34 kg)  
 Estante (caudal máximo kg. 34)

46.2 x 40.8 x 2.6 **RL 0504 01** **31** - **27** - 4 0.01



96.2 x 40.8 x 2.5 **RM 1004 01 AL** **21** 7 0.02

Ripiano (portata max. kg. 34)  
 Top (max. cap. 34 kg)  
 Etagere cap. max. 34 kg  
 Ablagefach (max. tragfähigkeit 34 kg)  
 Elegplank (max. draagvermogen 34 kg)  
 Estante (caudal máximo kg. 34)

96.2 x 40.8 x 2.5 **RL 1004 01** **58** - **48** - 8 0.02

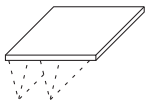

46.2 x 40.8 x 2.5 **AZ 0504 MO AF** **27** - - 2 0.01

Ripiano metallico (portata max. kg. 34) (attrezzato portacartelle da cm. 33)  
 Metal top (max. cap. 34 kg) (equipped for 33 cm suspended files)  
 Etagere metal. (cap. max. 34 kg) (equipee pour dossiers suspendus de 33 cm)  
 Melamin-ablagefach (max. tragfähigkeit 34 kg) (mit 33 cm-hängeregister)  
 Metalen legplank (max. draagvermogen 34 kg) (geschikt voor hangmappen van 33 cm)  
 Estante metálico (caudal de carga máxima kg. 34) (equipado portacarpetas de cm. 33)

AF													

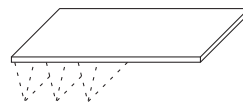

96.2 x 40.8 x 2.5 **AZ 1004 MO AF** **35** - - 4 0.01

Ripiano metallico (portata max. kg. 59) (attrezzato portacartelle da cm. 33)  
 Metal top (max. cap. 59 kg) (equipped for 33 cm suspended files)  
 Etagere metal. (cap. max. 59 kg) (equipee pour dossiers suspendus de 33 cm)  
 Melamin-ablagefach (max. tragfähigkeit 59 kg) (mit 33 cm-hängeregister)  
 Metalen legplank (max. draagvermogen 59 kg) (geschikt voor hangmappen van 33 cm)  
 Ripiadi metálico (capacidad de carga máxima kg. 59) (equipado portacarpetas de cm. 33)

**Complementi per armadi**  
**Complementary accessories for cabinets**  
**Complements pour armoires**  
**Schrankzubehörteile**  
**Kastaccessoires**  
**Complementos para armarios**

Dimensioni (cm) Dimensions Dimensions Abmessungen Afmetingen Dimensiones <b>L x P x H</b>	Codice Code Code Nummer Code Código	Prezzo - Price - Prix - Preis - Prijs - Precio									Peso Weight Poids Gewicht Peso <b>Kg</b>	Volume Volume Volume Volume Volume <b>m³</b>
		Finiture - Finishes - Finitions Ausführungen - Afwerkingen - Acabados										
		[ ] [ ] [ ]			[ ] [ ] [ ]			[ ] [ ] [ ]				



96 x 3 x 2      **AZ 1000 00 AF**      **25**      1      0.01

Barra di rinforzo per piani intermedi per armadio  
 Reinforced bar for cabinet intermediate shelves  
 Barre de renforcement pour plateaux intermediaires pour armoire  
 Verstärkung für schrank-zwischenfächer  
 Verstevigingsprofiel voor tussenplank  
 Barra de refuerzo para planos intermedios para armario

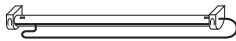

35 x 2 x 5      **AZ 0400 00 00**      **20**      0.01      0.01

Appendiabiti per armadio  
 Cupboard coatrack  
 Penderie a crochets pour armoire  
 Kleiderhaken für schrank  
 Kastklerehangers  
 Perchero para armario

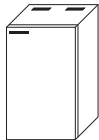

Frigorifero da incasso per mobili da cm. 50 (220V - 50 Hz, capacita' 38 lt.)  
 compresa predisposizione armadio (anta dx)

Built-in refrigerator for 50 cm. units (220V - 50 Hz, 38 l. capacity)  
 including cupboard arrangement (door rh)

39 x 40 x 64      **AZ 0405 00 00**      **701**      20      0.12

Refrigerateur a encastrer dans des meubles de cm. 50 (220V - 50 Hz,  
 capacite' 38 lt.) y compris la predisposition de l'armoire (porte dr)

Kühlschrank für den einbau in elemente ausmass 50 cm (220V - 50 Hz,  
 nutzinhalt 38 l) inkl. vorbereitung für schrank (türen re)

Inbouwkoelkast voor meublen van 50 cm (220V - 50Hz, capaciteit 38 l)  
 inclusief kastvoorbereiding (aan re)

Nevera para empotrado para muebles de cm. 50 (220 v - 50 hz,  
 capacidad 38 lt) incluyendo la preparación para el armario (puerta de)

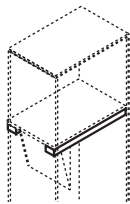

95 x 3 x 3      **AZ 9503 00 AF**      **24**      1      0.01

Coppia barre portacartelle da fissare su ripiano (cartelle da 33 cm)

Inglese  
 Francese  
 Tedesco  
 Fiammingo  
 Spagnolo

**Complementi per armadi**  
**Complementary accessories for cabinets**  
**Complements pour armoires**  
**Schrankzubehörteile**  
**Kastaccessoires**  
**Complementos para armarios**

Dimensioni (cm) Dimensions Dimensions Abmessungen Afmetingen Dimensiones <b>L x P x H</b>	Codice Code Code Nummer Code Código	Prezzo - Price - Prix - Preis - Prijs - Precio									Peso Weight Poids Gewicht Peso <b>Kg</b>	Volume Volume Volume Volumen Volume <b>m<sup>3</sup></b>
		Finiture - Finishes - Finitions Ausführungen - Afwerkingen - Acabados										
		□ □ □			□ □ □			□ □ □				

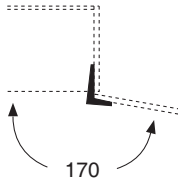

<b>AZ 0170 00 00</b>	<b>8</b>	0.01	0.01
----------------------	----------	------	------

Cerniere per ante (Apertura a 170°)  
 Doors hinges (170° opening)  
 Charnières pour portes (Ouverture à 170°)  
 Scharniere für Türen (Öffnungswinkel 170°)  
 Scharnieren voor deurtjes (Opening aan 170°)  
 Bisagras para puertas (apertura de 170°)

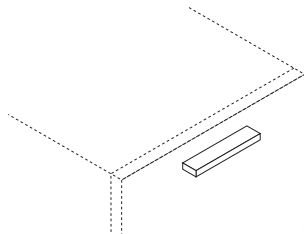

12 x 1.6 x 1	<b>MA 1210 01 AF</b>	<b>5</b>	0.01	0.01
--------------	----------------------	----------	------	------

Maniglia metallica colore alluminio  
 Aluminium colour metal handle  
 Poignée en métal teinte aluminium  
 Metallgriff aluminiumfarbig  
 Metalen handgreep in aluminium kleur  
 Manilla metálica color aluminio

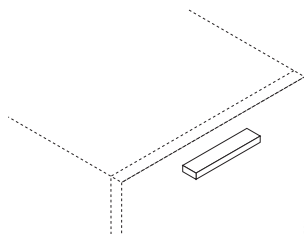

12 x 1.6 x 1	<b>MA 1210 01 KR</b>	<b>7</b>	0.01	0.01
--------------	----------------------	----------	------	------

Maniglia metallica colore cromo  
 Chrome colour metal handle  
 Poignée métallique couleur chrome  
 Chromfarbener Metallgriff  
 Chromkleurige metalen handgreep  
 Manilla metálica color cromo

**Complementi per armadi**  
**Complementary accessories for cabinets**  
**Complements pour armoires**  
**Schrankzubehörteile**  
**Kastaccessoires**  
**Complementos para armarios**

Dimensioni (cm) Dimensions Dimensions Abmessungen Afmetingen Dimensiones <b>L x P x H</b>	Codice Code Code Nummer Code Código	Prezzo - Price - Prix - Preis - Prijs - Precio			Peso Weight Poids Gewicht Peso <b>Kg</b>	Volume Volume Volume Volumen Volume Volumen <b>m<sup>3</sup></b>
		Finiture - Finishes - Finitions Ausführungen - Afwerkingen - Acabados				
		<input type="checkbox"/>	<input type="checkbox"/>	<input type="checkbox"/>		

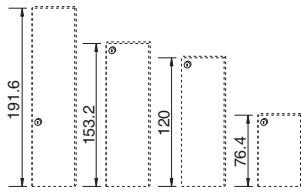

**AZ 0006 S1 00**

**10**

0.01 0.01

- (kit) serratura per ante legno
- (kit) lock single wood door
- (kit) ser. porte simple bois
- (kit) schloss einzel-holztür
- (set) slot voor enkele houten deur
- (kit) cerradura para puertas madera

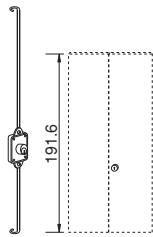

**AZ 0008 S1 00**

**33**

0.01 0.01

- (kit) serratura per ante legno
- (kit) lock single wood door
- (kit) ser. porte simple bois
- (kit) schloss einzel-holztür
- (set) slot voor enkele houten deur
- (kit) cerradura para puertas madera

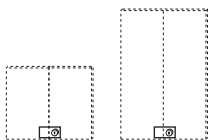

**AZ 0009 S1 00**

**24**

0.01 0.01

- (kit) serratura per coppia ante VG
- (kit) lock: VG glass door
- (kit) ser. porte vitree VG
- (kit) schloss VG glastür
- (kit) slot VG glazen deur
- (kit) cerradura par de puertas VG

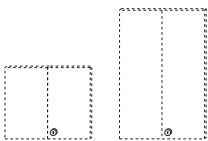

**24**

0.01 0.01

- (kit) serratura per ante VG
- (kit) lock: VG glass door
- (kit) ser. porte vitree VG
- (kit) schloss VG glastür
- (kit) slot VG glazen deur
- (kit) cerradura par de puertas VG

**Complementi per armadi**  
**Complementary accessories for cabinets**  
**Complements pour armoires**  
**Schrankzubehörteile**  
**Kastaccessoires**  
**Complementos para armarios**

Dimensioni (cm) Dimensions Dimensions Abmessungen Afmetingen Dimensiones <b>L x P x H</b>	Codice Code Code Nummer Code Código	Prezzo - Price - Prix - Preis - Prijs - Precio												Peso Weight Poids Gewicht Peso <b>Kg</b>	Volume Volume Volume Volume Volume <b>m<sup>3</sup></b>
		Finiture - Finishes - Finitions Ausführungen - Afwerkingen - Acabados													
		CL	PT	L-	AL										
		NT													

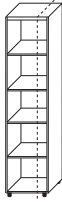

Riduzione struttura armadio in larghezza  
 Customised reduction of width of standard cabinet structure  
 Coupe sur mesure de la structure de l'armoire en largeur  
 Kürzen des Schrankgestells in der Breite  
 Inkorting breedte kast  
 Reducción estructura armario en anchura

<b>SP 0508 RI</b>	<b>163</b>	<b>130</b>	-	-	-
<b>SP 0512 RI</b>	<b>195</b>	<b>151</b>	-	-	-
<b>SP 0516 RI</b>	<b>227</b>	<b>173</b>	-	-	-
<b>SP 0520 RI</b>	<b>260</b>	<b>195</b>	-	-	-

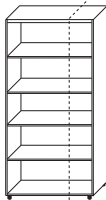

Riduzione struttura armadio in larghezza  
 Customised reduction of width of standard cabinet structure  
 Coupe sur mesure de la structure de l'armoire en largeur  
 Kürzen des Schrankgestells in der Breite  
 Inkorting breedte kast  
 Reducción estructura armario en anchura

<b>SP 1008 RI</b>	<b>163</b>	<b>130</b>	-	-	-
<b>SP 1012 RI</b>	<b>195</b>	<b>151</b>	-	-	-
<b>SP 1016 RI</b>	<b>227</b>	<b>173</b>	-	-	-
<b>SP 1020 RI</b>	<b>260</b>	<b>195</b>	-	-	-

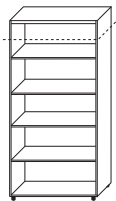

Riduzione struttura armadio in altezza  
 Customised reduction of height of standard cabinet structure  
 Coupe sur mesure de la structure de l'armoire en hauteur  
 Kürzen des Schrankgestells in der Höhe  
 Inkorting hoogte kast  
 Reducción estructura armario en altura

<b>SP 0000 RI</b>	<b>163</b>	<b>130</b>	-	-	-
-------------------	------------	------------	---	---	---

**Complementi per armadi**  
**Complementary accessories for cabinets**  
**Complements pour armoires**  
**Schrankzubehörteile**  
**Kastaccessoires**  
**Complementos para armarios**

Dimensioni (cm) Dimensions Dimensions Abmessungen Afmetingen Dimensiones <b>L x P x H</b>	Codice Code Code Nummer Code Código	Prezzo - Price - Prix - Preis - Prijs - Precio									Peso Weight Poids Gewicht Peso <b>Kg</b>	Volume Volume Volume Volumen Volume Volumen <b>m<sup>3</sup></b>
		Finiture - Finishes - Finitions Ausführungen - Afwerkingen - Acabados										
		CL	PT	L	RN	WE	AC					
RS	NT	AM	GP	BL								



**SP 1111 RI**

**76**

**54**

**-**

**-**

**-**

Riduzione 1 anta in larghezza  
 Customised reduction of width, removal of 1 standard door  
 Coupe sur mesure 1 porte en largeur  
 Kürzen 1 Tür in der Breite  
 Inkorting breedte 1 deurtje  
 Reducción 1 puerta en anchura



**SP 2222 RI**

**76**

**54**

**-**

**-**

**-**

Riduzione 1 anta in altezza  
 Customised reduction of height, removal of 1 standard door  
 Coupe sur mesure 1 porte en hauteur  
 Kürzen 1 Tür in der Höhe  
 Inkorting hoogte 1 deurtje  
 Reducción 1 puerta en altura